



ZEISS IKON - VOIGTLÄNDER
OF AMERICA, INC.

EXCLUSIVE DISTRIBUTORS OF

ZEISS IKON
VOIGTLÄNDER

CAMERAS, PROJECTORS AND ACCESSORIES

CARL ZEISS

BINOCULARS, THEATRE GLASSES AND MAGNIFIERS

METZLER® international
ZEISS UMBRAL SUNGLASSES

METZ

MECABLITZ ELECTRONIC FLASHGUNS



METZLER®
international



ZEISS IKON-VOIGTLÄNDER
of AMERICA, INC.

444 FIFTH AVENUE, NEW YORK, NEW YORK 10018

279-7880

Area Code 212

SINGLE LENS REFLEX CAMERAS

- SECTION A **CONTAREX CAMERA SYSTEM**
- SECTION B **CONTAFLEX 35mm CAMERA SYSTEM**
- SECTION C **ICAREX 35mm CAMERA SYSTEM**
- SECTION D **CONTAFLEX 126 CAMERA SYSTEM**

VIEWFINDER CAMERAS

- SECTION E **35mm VIEWFINDER CAMERAS**
- SECTION F **#126 VIEWFINDER CAMERAS**
- SECTION G **MOVIE AND PROJECTION**
 - Moviflex S8, camera
 - Movilux S8 and DS8 movie projectors
 - Perkeo, slide projectors
 - Moviscop, viewer and editor
- SECTION H **CAMERA ACCESSORIES**
 - Flashguns — Exposure Meters
 - Bessamatic — Ultramatic Lenses and Accessories
- SECTION I **PROFESSIONAL LENSES**
- SECTION J **METZLER international — ZEISS UMBRAL**
 - Sunglasses
- SECTION K **CARL ZEISS**
 - Binoculars/Magnifiers
 - Theatre Glasses
- SECTION L **METZ**
 - Mecablitz Electronic Flashguns

All prices, specifications and technical data subject to change without notice.

This confidential price list supersedes all previous price lists.

Item
Number

DESCRIPTION

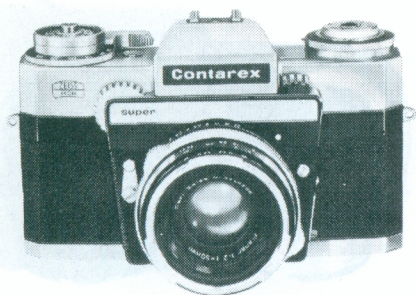

10.2600

CONTAREX SUPER:

- Built-in CdS exposure meter with through-the-lens metering. Meter coupled to shutter speeds and lens diaphragm. Meter angle: 7° only with 50mm lens. Equal to 7% of picture area.
- Focal plane shutter with speeds of 1 sec. to 1/1000 sec. plus B and built-in self timer.
- Large pentaprism viewfinder with interchangeable viewing screens.
- Instant-return mirror.
- F-stops and shutter speeds visible in viewfinder and on top of camera for convenient eye level and waist level adjustments.
- Flash synchronization color-coded for flash bulbs and strobe units. Hot shoe flash contact and regular PC outlet with locking device on camera body.
- Provisions for data recording on film at time of exposure.

LENSES

Interchangeable lenses, all bayonet-mounted, ranging from 18mm to 1000mm.

- 18mm to 250mm lenses with automatic pre-set diaphragms.
- B-Planar and B-Distagon with built-in automatic flash control.
- Automatic diaphragm compensation for close-up photography for 25 to 55mm lenses.

Complete range of accessories including interchangeable Magazine Backs, Copy Stand, Adapter for Photomicrography, Lens Shades, Filters, Close-up Lenses and many others.

10.2600	CONTAREX SUPER® , chrome finish*, with interchangeable split-image viewing screen and ground-glass ring, body only, lens and case extra	445.00
*Camera body with black finish, see below, \$24.00 extra.		
10.2600 11.2407	Camera body, as above } PLANAR® f/1.4, 55mm }	684.00
10.2600 11.2412	Camera body, as above } B-PLANAR® f/2, 50mm }	634.00
10.2600 11.2501	Camera body, as above } TESSAR® f/2.8, 50mm }	534.00
10.2600-BL	CONTAREX® SUPER , black finish, camera body only, lens and case extra	469.00
23.0008	CASE, EVEREADY , for Contarex super	29.00

CONTAREX PROFESSIONAL

Same features as Contarex Super, but no built-in exposure meter.

10.2700	CONTAREX® P with interchangeable split-image viewing screen and ground-glass ring, body only, lens and case extra	315.00
10.2700 11.2407	Camera body, as above } PLANAR® f/1.4, 55mm }	554.00
10.2700 11.2412	Camera body, as above } B-PLANAR® f/2, 50mm }	504.00
10.2700 11.2501	Camera body, as above } TESSAR® f/2.8, 50mm }	404.00
23.0008	CASE, EVEREADY , for Contarex P	29.00



10.2700

DESCRIPTION

Item
Number

INTERCHANGEABLE LENSES

DISTAGON f/4, 18mm, automatic preset	330.00	11.2418
DISTAGON , f/2.8, 25mm, automatic preset	276.00	11.2408
DISTAGON , f/2, 35mm, automatic preset	279.00	11.2414
B-DISTAGON f/4, 35mm, automatic preset, with built-in flash automation	209.00	11.2413
B-PLANAR ® f/2, 50mm, automatic preset, with built-in flash automation	189.00	11.2412
TESSAR ® f/2.8, 50mm, automatic preset	89.00	11.2501
S-PLANAR ® f/4, 50mm for scale reproductions at 1:2.8 to 1:13 only	269.00	11.2415
PLANAR ® f/1.4, 55mm, automatic preset	239.00	11.2407
SONNAR ® f/2, 85mm, automatic preset	232.00	11.2404
TESSAR ® f/3.5, 115mm, manually preset (for use with BELLOWS EXTENSION only)	289.00	11.2417
SONNAR ® f/4, 135mm, automatic preset	185.00	11.2405
OLYMPIA SONNAR ® f/2.8, 135mm automatic preset	239.00	11.2409
OLYMPIA SONNAR ®, f/2.8, 180mm, automatic preset	515.00	11.2425
OLYMPIA SONNAR ®, f/4, 250mm automatic preset, with rapid focusing grip with case	549.00	11.2421
VARIO-SONNAR ®, f/2.8, 40-120mm, zoom lens	660.00	11.2423
VARIO-SONNAR ® f/4, 85-250mm zoom lens	849.00	11.2424
MONOCULAR , 8x30 B, f/16, 400mm tele attachment	108.00	20.1629
CASE , leather, for Monocular	12.00	23.1203
ADAPTER RING to attach Monocular 8x30 B to Contarex (50mm Planar or Tessar only)	7.50	20.1639
ADAPTER RING to attach Monocular 8x30 B to Planar f/1.4, 55mm	19.50	20.1642
MIROSTAR ® f/4.5, 500mm, mirror-reflex (catadioptric) lens with case	1312.00	11.2420
MIROSTAR ® f/5.6, 1000mm, mirror-reflex (catadioptric) lens with case	3990.00	11.2422



11.2408 11.2414



11.2421



11.2420

OPTIONAL INTERCHANGEABLE VIEWFINDER SCREENS

VIEWING SCREEN , full ground-glass	7.50	20.1312
VIEWING SCREEN , split-image with ground-glass ring for 25mm to 135mm lenses	7.50	20.1310
VIEWING SCREEN , split-image for 250mm lens	7.50	20.1311
VIEWING SCREEN , clear-glass with cross-line reticule for photomicrography	13.50	20.1313
VIEWING SCREEN , full ground-glass with split-image indicator	10.00	20.1314
CONTAINER , with tweezers and soft-hair brush (holds up to 4 viewing screens)	15.00	20.7074
DATA RECORDING STRIPS in bag (100 each)	7.50	20.0202

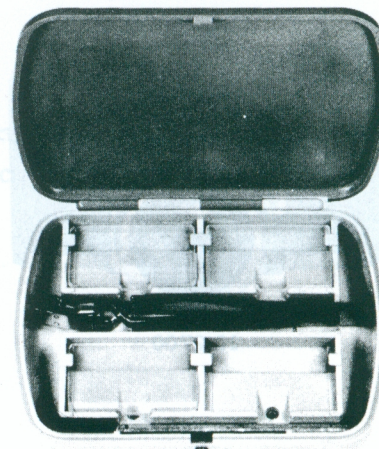

20.7074

Item
Number

DESCRIPTION



11.2425

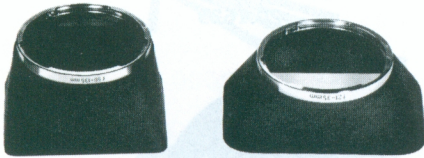

20.0710 20.0712

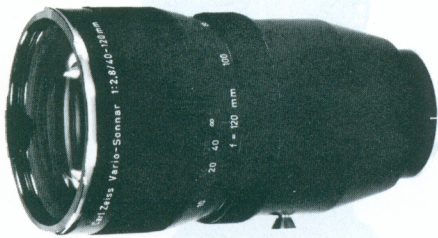

11.2423



11.2409

20.0627	DUST CAP for camera body	1.00
20.0609	LENS CAP for front of lens (21mm to 135mm)	1.00
20.0625	LENS CAP, rear, 25mm to 250mm lenses	1.00
20.0624	LENS CAP, front, 250mm lens	1.00
23.7756	LEATHER CASE for Distagon f/4, 35mm or any 50mm lens	18.00
23.7757	LEATHER CASE for 25mm, Distagon f/2, 35mm, 55mm or 85mm lens	18.00
23.7758	LEATHER CASE for 135mm lens	18.00
23.1002	LEATHER CASE for 250mm Olympia-Sonnar	21.00
20.7002	PLASTIC CONTAINER for Distagon f/4, 35mm or one 50mm lens	3.00
20.7008	PLASTIC CONTAINER for 25mm, 55mm or 85mm lens	3.00
20.7003	PLASTIC CONTAINER for Distagon f/2, 35mm or one 135mm lens	3.00
20.0710	LENS SHADE, bayonet mount, 56mm for 21, 25, and 35mm lenses	9.00
20.0712	LENS SHADE, bayonet mount, 56mm for 50, 55, 85, 115 and 135mm lenses	9.00
23.7838	CASE, leather, for #20.0710 lens shade	4.50
23.7837	CASE, leather, for #20.0712 lens shade	4.50
FILTER, bayonet mount, 56mm for 21, 25, 35, 50, 55, 85, 115 and 135mm lenses. each		19.50
20.1065	Ultra Violet 1x	
20.1061	Yellow 2x	
20.1062	Yellow Green 2x	
20.1063	Orange 3x	
20.1064	Red 8x	
20.1068	Skylight for daylight type color films.	
20.1012	85B for Super-Anscochrome Tungsten, High Speed Ektachrome, Type B	
FILTER, bayonet mount, 96mm for 18mm Distagon and Vario Sonnar lenses		
20.1071	Yellow 3x	39.00
20.1075	UV 1x	39.00
20.1078	Skylight	48.00

THE CONTAREX® CAMERA SYSTEM

ZEISS IKON
VOIGTLANDER

DESCRIPTION

Item
Number

FILTERS, screw-in mount, 67mm for 250mm lens each **24.00**

Ultra Violet 1x **20.1045**

Yellow 2x **20.1041**

Skylight for daylight color films. **20.1048**

85B for Super Anscochrome Tungsten, High Speed Ektachrome, Type B **20.1049**

CONTAPOL, polarizing filter in bayonet mount, 56mm **36.00** **20.1206**
The Contapol subdues reflections on glass, water, and other non-metallic surfaces, darkens blue skies in color photography without changing subject colors. The filter factor is approx. 3X.

CASE, Leather, black, for one filter or one Proxar lens or one Contapol in 56mm bayonet mount only **3.00** **23.2001**

CASE, Leather, black, for one 67mm filter **3.00** **23.2002**

ACCESSORIES FOR CLOSE-UP PHOTOGRAPHY

PROXAR® CLOSE-UP LENS, bayonet mount, 56mm, 5x, f=0.2m (for distances 4-8 in.) **18.00** **20.0840**
Approx. minimum coverage: 1³/₄"x2¹/₂"*
Approx. maximum coverage: 3³/₈"x5¹/₄"*
*With 50mm lens

PROXAR® CLOSE-UP LENS, bayonet mount, 56mm 1 dptr., f=1 meter for Sonnar 85mm and Sonnar 135mm **18.00** **20.0843**
Focusing with 85mm: 15¹/₂" to 39"
Focusing with 135mm: 20" to 39"
Approx. area cover. 85mm: 10¹/₄"x15³/₄" to 4"x6"
Approx. area cover. 135mm: 6³/₄"x10¹/₄" to 3"x4¹/₂"

PROXAR® CLOSE-UP LENS, bayonet mount, 56mm 2 dptr., f=0.5 meter for Sonnar 85mm and Sonnar 135mm **18.00** **20.0844**
Focusing with 85mm: 11¹/₂" to 20"
Focusing with 135mm: 14" to 20"
Approx. area cover. 85mm: 5¹/₄"x8" to 3"x4¹/₄"
Approx. area cover. 135mm: 3¹/₂"x5¹/₄" to 2"x3"

PROXAR® CLOSE-UP LENS, bayonet mount, 56mm 3 dptr., f=0.35 meter for Sonnar 85mm and Sonnar 135mm **18.00** **20.0845**
Focusing with 85mm: 9" to 13¹/₂"
Focusing with 135mm: 10¹/₄" to 13¹/₂"
Approx. area coverage 85mm: 3¹/₂"x5" to 2¹/₄"x3¹/₄"
Approx. area coverage 135mm: 2¹/₄"x3¹/₂" to 1¹/₂"x2¹/₄"

FOCUSING BELLOWS EXTENSION double track **99.00** **20.1617**
Approx. permissible field sizes with:
35mm lens: 1⁴/₄"x3³/₈" to 1x1¹/₂"*
50mm lens: 3³/₈"x5⁵/₈" to 1⁵/₈" to 2³/₈"*
85mm lens: 5⁵/₈"x1" to 2⁷/₈"x3³/₄"*
135mm lens: 1x1¹/₂" to 3¹/₂"x5¹/₄"*
*With 115mm lens: Infinity to natural size (1:1)

TESSAR® f/3.5, 115mm, in short barrel mount, including twin cable release, leather pouch (for use with Bellows Extension **only**) **289.00** **11.2417**

BELLOWS LENS HOOD (Compendium) for use with Focusing Bellows Extension **30.00** **20.1631**

CLOSE-UP LENS, with adapter ring for slide duplication (ratio 1:1) with Planar f/2, 50mm, focusing bellows and bellows lens hood **12.00** **20.1636**

CLOSE-UP LENSES for Monocular 8x30B

+1 dptr. lens, field: 2"x3" **18.00** **20.0831**

+2 dptr. lens, field: 1¹/₄"x1³/₄" **21.00** **20.0832**

+3 dptr. lens, field: 3³/₄"x1¹/₄" **21.00** **20.0833**

+5 dptr. lens, field: 1¹/₂"x3³/₄" **39.00** **20.0834**

+8 dptr. lens, field: 1¹/₄"x1¹/₂" **30.00** **20.0835**



20.1629



20.1639

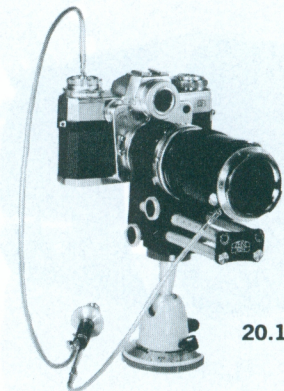

20.1617

Item
Number

DESCRIPTION

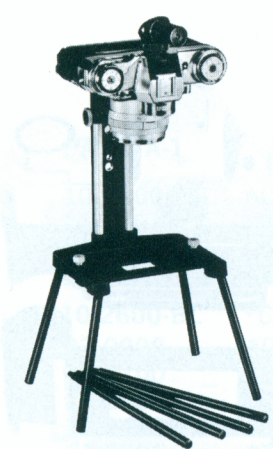

20.1853

TABLE REPRODUCTION STAND consisting of:		
20.1826	Table Clamp	18.00
20.1819	Pillar 2' long	18.00
20.1828	Connecting Arm	18.00
20.1824	Camera Adapter	18.00

LIGHTING UNIT FOR TABLE REPRODUCTION STAND:		
20.1810	1 T-Clamp	15.00
20.1820	1 Transverse Tube	15.00
20.1811	2 Clamps	each 15.00
20.1808	2 Tubes for carrying Reflector	each 7.50
20.1813	4 Reflectors, articulated tubes and U.S. adapter	each 20.00
20.1812	4 Clamps	each 15.00

20.1633	ADAPTER RING for Luminar lenses	21.00
---------	----------------------------------------------	-------

20.1853	REPROPHOT , portable copystand for object sizes: 8"x12" to 1"x1½" (natural size)	89.00
---------	--------------------------------------------------------------------------------------------------	-------

20.1634	RIGHT-ANGLE VIEW-FINDER for viewing and focusing at waist-level and for copy work, photomicrography. Mirror reflex view-finder with adjustable eyepiece which is fitted to the eyepiece of the camera	36.00
---------	--------------------------------------------------------------------------------------------------------------------------------------------------------------------------------------------------------------------	-------

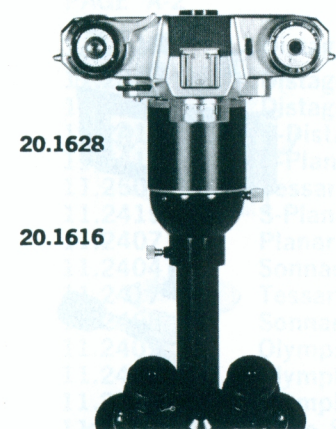

20.1628

20.1616

MICRO ATTACHMENT for 25mm Eyepiece Sleeve, consisting of:		
20.1628	1 Contarex Adapter	15.00
20.1616	1 Connecting Ring	18.00

CARRYING CASES

23.0203	DELUXE CARRYING CASE for Contarex	36.00
Holds Contarex with one lens on camera, two filters and one lens shade		

23.0204	SMALL UNIVERSAL CARRYING CASE for Contarex	54.00
Holds Contarex with one lens on camera, one additional lens (up to 135mm, except 21mm Biogon), one Interchangeable Back, two filters and one lens shade.		

23.0205	LARGE UNIVERSAL CARRYING CASE for Contarex	75.00
Holds Contarex with standard lens, three additional lenses, except 21mm Biogon, one Interchangeable Back, one Monocular 8x30B or one Interchangeable Back, two filters, two lens shades, adapter ring for Monocular 8x30B and one cable release, locking.		

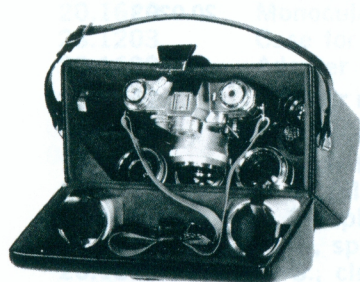

23.0205

23.7842	LENS CARRYING CASE for Contarex lenses and accessories	42.00
Holds the 21mm Biogon, 135mm Sonnar and one additional lens (35mm, 50mm or 85mm) plus the 21mm viewfinder. There is space for either two 56mm filters or one filter and the Proxar close-up lens. In addition it holds either one interchangeable back or two 56mm lens shades.		

THE CONTAREX® CAMERA SYSTEM

ZEISS IKON
VOIGTLÄNDER

DESCRIPTION

Item
Number

SUNDRY ACCESSORIES FOR CONTAREX

INTERCHANGEABLE MAGAZINE BACK	69.00	20.0304
LEATHER CASE for one interchangeable magazine back	12.00	23.7856
LEATHER CASE for two interchangeable magazine backs	12.00	23.0200
CABLE RELEASE, locking, 10-in. long, with special locking device for longtime exposures	2.95	20.0281
TRIPOD EXTENSION PIECE	9.00	20.0203
RUBBER EYE CUP for viewfinder	2.50	35.0207
TAKE-UP SPOOL, made of plastic, with tooth for anchoring film	1.00	20.0001
NECK STRAP, black leather	1.95	23.0211
EYE-CORRECTION LENS (spherical only) from ± 0.5 to ± 5 diop- ters in steps of 0.5 each, for Contarex and Contarex Special with penta prism viewfinder attachment, special order only together with prescription for eye used	6.00	20.0504
CASSETTE, complete. For using "Bulk" film	12.00	20.0300
CORE, for Cassette	1.00	20.0301

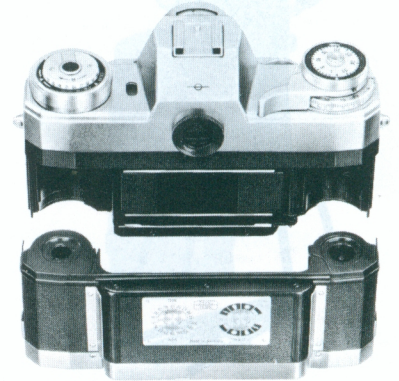

20.0304

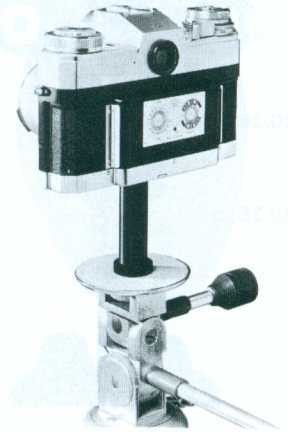

20.0203

EXPOSURE METERS AND FLASHGUNS

SEE SECTION H

CONFIDENTIAL DEALER PRICE SCHEDULE

EFFECTIVE MARCH 1, 1968

ZEISS IKON
VOIGTLÄNDER

SECTION A — CONTAREX

All items are in Order of Appearance in Catalog Pages

PAGE A-1	List	1-2 pc. net	3 and more pc. net	
10.2600	*Contarex Super, body only	445.00	296.67	—
11.2407	*Planar f/1.4, 55mm	239.00	159.33	—
11.2412	*B-Planar f/2, 50mm	189.00	126.00	—
11.2501	*Tessar f/2.8, 50mm	89.00	59.33	—
10.2600-BL	*Contarex Super, body only — Black ..	469.00	312.67	—
23.0008	*Case	29.00	19.33	—
10.2700	*Contarex P, body only	315.00	210.00	—
11.2407	*Planar f/1.4, 55mm	239.00	159.33	—
11.2412	*B-Planar f/2, 50mm	189.00	126.00	—
11.2501	*Tessar f/2.8, 50mm	89.00	59.33	—
23.0008	*Case	29.00	19.33	—
PAGE A-2				
11.2418	Distagon f/4, 18mm	330.00	220.00	—
11.2408	Distagon f/2.8, 25mm	276.00	184.00	—
11.2414	Distagon f/2, 35mm	279.00	186.00	—
11.2413	B-Distagon f/4, 35mm	209.00	139.33	—
11.2412	B-Planar f/2, 50mm	189.00	126.00	—
11.2501	Tessar f/2.8, 50mm	89.00	59.33	—
11.2415	S-Planar f/4, 50mm	269.00	179.33	—
11.2407	Planar f/1.4, 55mm	239.00	159.33	—
11.2404	Sonnar f/2, 85mm	232.00	154.67	—
11.2417	Tessar, f/3.5, 115mm	289.00	192.67	—
11.2405	Sonnar f/4, 135mm	185.00	123.33	—
11.2409	Olympia Sonnar f/2.8, 135mm	239.00	159.33	—
11.2425	Olympia Sonnar f/2.8, 180mm	515.00	343.33	—
11.2421	Olympia Sonnar f/4, 250mm	549.00	366.00	—
11.2423	Vario Sonnar f/2.8, 40-120mm	660.00	440.00	—
11.2424	Vario Sonnar f/4, 85-250mm	849.00	566.00	—
20.1629	Monocular 8 x 30B	108.00	72.00	68.40
23.1203	Case for Monocular	12.00	8.00	7.60
20.1639	Adapter ring for M. 8 x 30B	7.50	5.00	—
20.1642	Adapter ring for M. 8 x 30B-55mm ...	19.50	13.00	12.35
11.2420	Mirotar f/4.5, 500mm	1,312.00	984.00	—
11.2422	Mirotar f/5.6, 1000mm	3,990.00	3,192.00	—
20.1312	V. S., full ground-glass	7.50	5.00	4.75
20.1310	V. S., split-image, 25-135mm	7.50	5.00	4.75
20.1311	V. S., split-image, 250mm	7.50	5.00	4.75
20.1313	V. S., clear-glass	13.50	9.00	8.55
20.1314	V. S., full ground-glass, split-image indicator	10.00	6.67	6.34
20.7074	Container w/Tweezers	15.00	10.00	9.50
20.0202	Data Recording Strips	7.50	5.00	4.75

*Fair-traded in the State of New York

CONFIDENTIAL DEALER PRICE SCHEDULE

EFFECTIVE MARCH 1, 1968

ZEISS IKON
VOIGTLANDER

SECTION A — CONTAREX

All items are in Order of Appearance in Catalog Pages

PAGE A-3		List	1-2 pc. net	3 and more pc. net
20.0627	Dust Cap	1.00	.67	.64
20.0609	Lens Cap, front	1.00	.67	.64
20.0625	Lens Cap, rear	1.00	.67	.64
20.0624	Lens Cap, front, 250mm	1.00	.67	.64
23.7756	Lens Case, 35, 50mm lens	18.00	12.00	11.40
23.7757	Lens Case, 25, 35, 55, 85mm lens ..	18.00	12.00	11.40
23.7758	Lens Case, 135mm lens	18.00	12.00	11.40
23.1002	Leather Case f/250mm lens	21.00	14.00	13.30
20.7002	Plastic Container f/35, 50mm	3.00	2.00	1.90
20.7008	Plastic Container f/55, 85mm	3.00	2.00	1.90
20.7003	Plastic Container f/135mm lens	3.00	2.00	1.90
20.0710	Lens Shade, 56mm	9.00	6.00	5.70
20.0712	Lens Shade, 56mm	9.00	6.00	5.70
23.7838	Leather Case	4.50	3.00	2.85
23.7837	Leather Case	4.50	3.00	2.85
20.1065	Filter, UV, 56mm	19.50	13.00	12.35
20.1061	Filter, Yellow, 56mm	19.50	13.00	12.35
20.1062	Filter, Yellow Green, 56mm	19.50	13.00	12.35
20.1063	Filter, Orange, 56mm	19.50	13.00	12.35
20.1064	Filter, Red, 56mm	19.50	13.00	12.35
20.1068	Filter, Skylight, 56mm	19.50	13.00	12.35
20.1012	Filter 85B, 56mm	19.50	13.00	12.35
20.1071	Filter, Yellow, 96mm	39.00	26.00	24.70
20.1075	Filter, UV, 96mm	39.00	26.00	24.70
20.1078	Filter, Skylight, 96mm	48.00	32.00	30.40
PAGE A-4				
20.1045	Filter, UV, 67mm	24.00	16.00	15.20
20.1041	Filter, Yellow, 67mm	24.00	16.00	15.20
20.1048	Filter, Skylight, 67mm	24.00	16.00	15.20
20.1049	Filter, 85B, 67mm	24.00	16.00	15.20
20.1206	Contapol, 3x	36.00	24.00	22.80
23.2001	Leather Case	3.00	2.00	1.90
23.2002	Leather Case	3.00	2.00	1.90
20.0840	Proxar 5x, 56mm	18.00	12.00	11.40
20.0843	Proxar 56mm + 1 dptr	18.00	12.00	11.40
20.0844	Proxar 56mm + 2 dptr	18.00	12.00	11.40
20.0845	Proxar 56mm + 3 dptr	18.00	12.00	11.40
20.1617	Bellows for Contarex	99.00	66.00	62.70
11.2417	Tessar, 115mm	289.00	192.67	—
20.1631	Bellows Lens Hood	30.00	20.00	19.00
20.1636	Close-up lens	12.00	8.00	7.60
20.0831	Close-up lens + 1 dptr.	18.00	12.00	—
20.0832	Close-up lens + 2 dptr.	21.00	14.00	—
20.0833	Close-up lens + 3 dptr.	21.00	14.00	—
20.0834	Close-up lens + 5 dptr.	39.00	26.00	—
20.0835	Close-up lens + 8 dptr.	30.00	20.00	—

CONFIDENTIAL DEALER PRICE SCHEDULE
EFFECTIVE MARCH 1, 1968

ZEISS IKON
VOIGTLANDER

SECTION A — CONTAREX

All items are in Order of Appearance in Catalog Pages

PAGE A-5		List	1-2 pc. net	3 and more pc. net
20.1826	Table Clamp	18.00	12.00	11.40
20.1819	Pillar	18.00	12.00	11.40
20.1828	Connecting Arm	18.00	12.00	11.40
20.1824	Camera Adapter	18.00	12.00	11.40
20.1810	T-Clamp	15.00	10.00	9.50
20.1820	Transverse Tube	15.00	10.00	9.50
20.1811	Clamp	15.00	10.00	9.50
20.1808	Tube	7.50	5.00	4.75
20.1813	Reflector	20.00	13.33	12.66
20.1812	Clamp	15.00	10.00	9.50
20.1633	Adapter Ring f/Luminar	21.00	14.00	13.30
20.1853	Reprophot	89.00	59.33	56.36
20.1634	Right-Angle Viewfinder	36.00	24.00	22.80
20.1628	Micro Adapter	15.00	10.00	9.50
20.1616	Connecting Ring	18.00	12.00	11.40
23.0203	Deluxe Carrying Case	36.00	24.00	22.80
23.0204	Small Universal Case	54.00	36.00	34.20
23.0205	Large Universal Case	75.00	50.00	47.50
23.7842	Lens Carrying Case	42.00	28.00	26.60
PAGE A-6				
20.0304	Interchangeable Magazine Back	69.00	46.00	(2) 43.70
23.7856	Case for one Magazine Back	12.00	8.00	7.60
23.0200	Case for two Magazine Backs	12.00	8.00	7.60
20.0281	Cable Release	2.95	1.97	(3) 1.87
				(12) 1.67
20.0203	Tripod Extension Piece	9.00	6.00	5.70
35.0207	Rubber Eye Cup	2.50	1.67	1.59
20.0001	Take-up Spool	1.00	.67	(3) .64
				(12) .58
23.0211	Neck Strap	1.95	1.30	1.23
20.0504	Eye Correction Lens	6.00	4.00	—
20.0300	Cassette	12.00	8.00	7.60
20.0301	Core	1.00	.67	.64

Item
Number

DESCRIPTION

CONTAFLEX® SUPER BC

- Through-the-lens metering (Cds)
- Fully automatic exposure control
- Automatic flash exposure control
- Built-in corrections for filters, dull and overcast daylight and back-lighting effects
- Coupled dual rangefinder
- "Command panel" viewfinder — all settings visible in viewfinder
- Rapid wind lever with double-exposure prevention
- Film type indicator
- Film counter
- Synchro-Compur shutter, 1 to 1/500 second and "B"
- Delayed-action release
- Synchronization contacts for bulbs or electronic flash (X-type)
- Interchangeable magazine back
- Bayonet mount for interchangeable lenses
- Attachments for copying and microscopic work
- Battery: Mallory PX-13 or PX-625



10.1273



11.1201



11.1205



20.1629

- | | | |
|---------|--------------------------------------------------------------------------------------------------------------------------------------|--------|
| 10.1273 | CONTAFLEX® Super BC, with Tessar f/2.8, 50mm, fully automatic Synchro Compur shutter up to 1/500 sec and selftimer, case extra | 229.50 |
| 23.0007 | CASE, Eveready, for Contaflex Super BC | 19.50 |

LENSES AND LENS ACCESSORIES

- | | | |
|--------------------------------------------|--------------------------------------------------------------------------------------------------------------------------------------------------------|--------|
| 11.1201 | PRO-TESSAR® f/3.2, 35mm, 60mm diameter, in plastic case, with lens cap | 94.00 |
| 11.1202 | PRO-TESSAR® f/3.2, 85mm, 60mm diameter, in plastic case, with lens cap | 99.95 |
| 11.1205 | PRO-TESSAR® f/4, 115mm, 67mm diameter, in plastic case, with lens cap | 105.00 |
| 11.1204 | PRO-TESSAR® M1:1, three elements | 69.00 |
| 20.0841 | CLOSE-UP LENS, threaded mount, 60mm 0.75 dptr., f = 1.3 meters for Pro-Tessar 85mm only | 19.50 |
| | Approx. area coverage from 8"x12" to 14½"x22" | |
| 20.0842 | CLOSE-UP LENS, threaded mount, 67mm 0.5 dptr., f = 2 meters for Pro-Tessar 115mm only | 24.00 |
| | Focusing with 115mm: 50" to 84" | |
| | Approx. area cover. 115mm: 16"x24" to 9"x14" | |
| 20.1629 | MONOCULAR 8x30 B, f/16, 400mm, tele attachment | 108.00 |
| 23.1203 | CASE, leather, for Monocular | 12.00 |
| CLOSE-UP LENSES for Monocular 8x30B | | |
| 20.0831 | +1 dptr. lens, field: 2"x3" | 18.00 |
| 20.0832 | +2 dptr. lens, field: 1¼x1¾" | 21.00 |
| 20.0833 | +3 dptr. lens, field: ¾x1¼" | 21.00 |
| 20.0834 | +5 dptr. lens, field: ½x¾" | 39.00 |
| 20.0835 | +8 dptr. lens, field: ¼x½" | 30.00 |
| 23.1001 | CASE, leather, for one Pro-Tessar and one filter | 15.00 |
| 23.1201 | CASE, leather, for two Pro-Tessar lenses (including 115mm lens), 50mm front element, two filters (60mm and 67mm) two lens shades (60mm and 67mm) | 21.00 |
| 23.0202 | CASE, leather for 3 Pro-Tessar lenses, one Interchangeable Magazine Back, 3 Proxar-close up lenses 28.5mm, one Filter each, 27mm, 60mm, 67mm | 42.00 |

CONTAFLEX® 35mm CAMERA SYSTEM

ZEISS IKON
VOIGTLÄNDER

DESCRIPTION

Item
Number

LENSES AND LENS ACCESSORIES (Cont'd)

UNIVERSAL CARRYING CASE for Contaflex super BC or B (also for super, prima)	66.00	23.0206
Holds: Contaflex with standard lens or one Pro-Tessar plus one Interchangeable Magazine Back, neck strap and one filter on camera. In addition provides space for two add. Pro-Tessars, Monocular 8x30B, one add. Interchangeable Back, 4 Proxar close-up lenses, four filters, 27mm, one filter 67mm, one Intermediate Ring 60mm/67mm #20.1643 one lens shade 27mm, 60mm and 67mm, rubber eye cup of monocular and 50mm Tessar lens.		
LENS CAP for front of 50mm Tessar	1.00	20.0602
LENS CAP , front, for 35mm and 85mm Pro-Tessars	1.00	20.0604
LENS CAP , front, for 115mm Pro-Tessar	1.00	20.0608
LENS CAP , rear, for all Pro-Tessars	1.00	20.0613
PLASTIC CONTAINER for one Pro-Tessar lens (35mm or 85mm) ..	3.00	20.7000
PLASTIC CONTAINER for one Pro-Tessar 115mm	3.00	20.7009



23.0202

INTERCHANGEABLE BACK AND CASES

INTERCHANGEABLE MAGAZINE BACK for Contaflex Super BC, B Super, Rapid, Prima	59.00	20.0302
CASE , leather, for one Interchangeable Magazine Back	12.00	23.7855
CASE , leather, for two Interchangeable Magazine Backs	12.00	23.0201

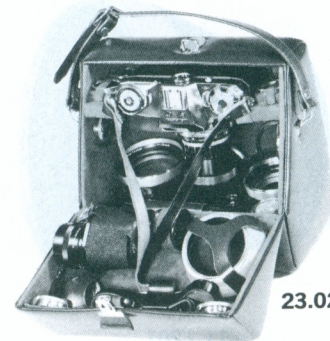

23.0206

FILTERS, LENS SHADES AND CASES

FILTER , Screw-In Mount, 67mm for 115mm lens	each 24.00	
Ultra Violet 1x		20.1045
Yellow 2x		20.1041
Skylight for daylight type films		20.1048
85B for Super-Anscochrome Tungsten, High Speed Ektachrome, Type B ..		20.1049
FILTER , Screw-Over Mount, 60mm, for Pro-Tessar 35 and 85mm	each 20.00	
Ultra Violet 1x		20.1035
Yellow 2x		20.1031
Yellow Green 2x		20.1032
Orange 3x		20.1033
Red 8x		20.1034
Skylight for daylight type color films		20.1038
LENS SHADE , screw-over mount, 60mm, rubber, for f/3.2, 35mm and 85mm Pro-Tessar	4.50	20.0716
LENS SHADE , Screw-In Mount, 67mm for 115mm Pro-Tessar ...	6.00	20.0714

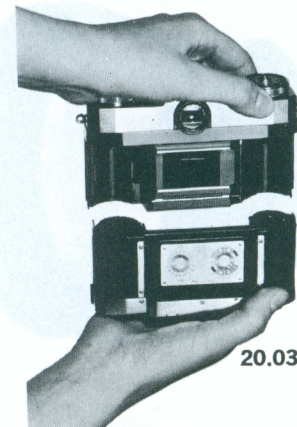

20.0302

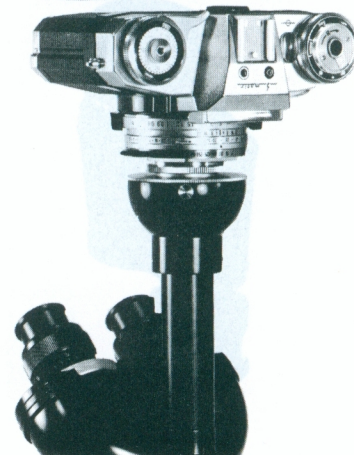

20.1616 20.1620

Item
Number

DESCRIPTION



20.7070

LENSES AND LENS ACCESSORIES (Cont'd)

23.2002	CASE, Leather, for 67mm filter	3.00
23.2003	CASE, leather, for lens shade 67mm	4.50
20.1643	INTERMEDIATE RING (step-up ring) 60 to 67mm to use 67mm filter with 35mm or 85mm Pro-Tessar	3.50
20.1011	INTERMEDIATE RING (step-up ring) from 49 to 60mm	3.50
20.1018	INTERMEDIATE RING (step-up ring) from 49 to 67mm	3.50
20.1620	MICRO ATTACHMENT for 25mm, Eyepiece Sleeve, consisting of: 1 Adapter ring	4.50
20.1616	1 Connecting ring	18.00

(Ocular with high eyepoint RECOMMENDED).

ACCESSORIES FOR ALL CONTAFLEX MODELS

FILTER, Screw-In Mount, 27mm for standard lens each 7.50

20.1025	Ultra Violet 1x
20.1021	Yellow 2x
20.1022	Yellow Green 2x
20.1023	Orange 5x
20.1024	Red 8x
20.1028	Skylight for Daylight type color films



20.1200

20.1200	CONTAPOL 3x, Polarizing filter	19.50
20.0602	LENS CAP for front of 45mm and 50mm Tessar and Pantar	1.00
20.0713	LENS SHADE, screw-in mount, 27mm, rubber	3.00

PROXAR® CLOSE-UP LENSES, slip-on mount, 28.5mm:

20.0800	1x, f = 1m (for distances 40 to 18 in.)	7.50
20.0801	2x, f = 0.5m (for distances 20 to 12 in.)	7.50
20.0802	3x, f = 0.3m (for distances 12 to 8 in.)	7.50
20.0803	4x, f = 0.2m (for distances 8 to 6 in.)	7.50

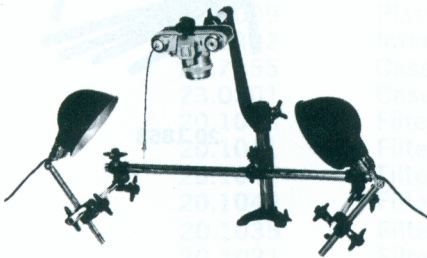

20.1826 20.1819 20.1828

20.7070	SET OF 4 PROXAR LENSES in plastic case with depth of field indicator	30.00
20.7059	CASE, plastic, for 4 Proxar lenses	2.50
20.0804	CLOSE-UP LENS, 10x, f = 0.1m (for distances 3½ to 4¼ in.), screw-in mount, 27mm	15.00

TABLE REPRODUCTION STAND consisting of:

20.1826	Table Clamp	18.00
20.1819	Pillar 2' long	18.00
20.1828	Connecting Arm	18.00
20.1824	Adapter with tripod screw for Contaflex rapid, super, prima, Super B, Super BC	18.00

DESCRIPTION

Item
Number

ACCESSORIES FOR ALL
CONTAFLEX® MODELS (Cont'd)

LIGHTING UNIT FOR TABLE REPRODUCTION STAND:

1 T-Clamp	15.00	20.1810
1 Transverse Tube	15.00	20.1820
2 Clamps	15.00	20.1811
2 Tubes for carrying Reflector	7.50	20.1808
4 Reflectors with articulated tubes and U.S. adapter	20.00	20.1813
4 Clamps	15.00	20.1812

RIGHT-ANGLE VIEWFINDER for viewing and focusing at waist-level and for copying work, photo-micrography, etc. 36.00 20.1614

REPROPHOT, portable copystand for object sizes: 8"x12" to 1x1½" (natural size) 89.00 20.1853

CASSETTE, complete
 12.00 | 20.0300 |

TAKE-UP SPOOL
 1.00 | 20.0001 |

CORE FOR CASSETTE
 1.00 | 20.0301 |

CABLE RELEASE, locking
 2.95 | 20.0281 |

NECK STRAP for camera
 1.95 | 23.0211 |

EYE-CORRECTION LENSES (spherical only) from ± 0.5 to ± 5 diopters in steps of 0.5 diopters each (on special order only together with prescription for eye used) 6.00 20.0504

RUBBER EYE CUP for viewfinder
 2.50 | 35.0207 |

TRIPOD EXTENSION PIECE (to use camera with Interchangeable Magazine Back on standard tripods) 9.00 20.0203

BOOKS:

The Contaflex Guide by W. D. Emanuel, 80 pages 1.95 65.0021
(Covers all 35mm models except Contaflex super BC)

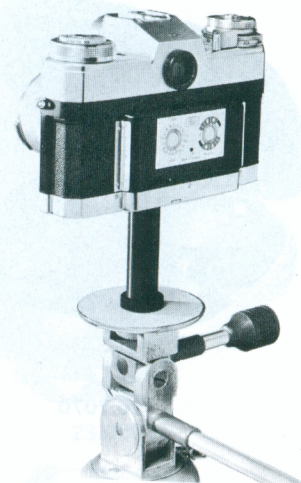

20.0203

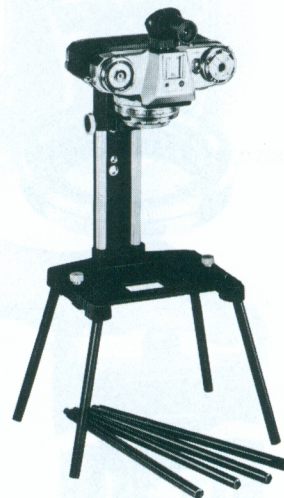

20.1853

HAND EXPOSURE METERS AND
FLASHGUNS

SEE SECTION H

CONFIDENTIAL DEALER PRICE SCHEDULE

EFFECTIVE MARCH 1, 1968

ZEISS IKON VOIGTLÄNDER

SECTION B — CONTAFLEX® 35mm

All items are in Order of Appearance in Catalog Pages

PAGE B-1		List	1-2 pc. net	3 and more pc. net
10.1273	*Contaflex super BC	229.50	153.00	145.35
23.0007	*Case	19.50	13.00	12.35
11.1201	Pro-Tessar, f/3.2, 35mm	94.00	62.67	59.54
11.1202	Pro-Tessar f/3.2, 85mm	99.95	66.63	63.30
11.1205	Pro-Tessar f/4, 115mm	105.00	70.00	66.50
11.1204	Pro-Tessar M 1:1	69.00	46.00	43.70
20.0841	Proxar 60mm + 0.75 dptr.	19.50	13.00	12.35
20.0842	Proxar 67mm + 0.5 dptr.	24.00	16.00	15.20
20.1629	Monocular 8 x 30B	108.00	72.00	68.40
23.1203	Case for Monocular	12.00	8.00	7.60
20.0831	Close-up lens + 1 dptr.	18.00	12.00	—
20.0832	Close-up lens + 2 dptr.	21.00	14.00	—
20.0833	Close-up lens + 3 dptr.	21.00	14.00	—
20.0834	Close-up lens + 5 dptr.	39.00	26.00	—
20.0835	Close-up lens + 8 dptr.	30.00	20.00	—
23.1001	Leather Case	15.00	10.00	9.50
23.1201	Case for 2 Pro-Tessars	21.00	14.00	13.30
23.0202	Case for 3 Pro-Tessars	42.00	28.00	26.60

PAGE B-2

23.0206	Universal Case	66.00	44.00	41.80
20.0602	Lens Cap, front	1.00	.67	.64
20.0604	Lens Cap, front, 35 & 85mm P.T.	1.00	.67	.64
20.0608	Lens Cap, front, P.T. 115mm	1.00	.67	.64
20.0613	Lens Cap, rear, P.T.	1.00	.67	.64
20.7000	Plastic Container, P.T.	3.00	2.00	1.90
20.7009	Plastic Container f/P.T. 115	3.00	2.00	1.90
20.0302	Interchangeable Magazine Back	59.00	39.33	(2) 37.36
23.7855	Case f/1 Magazine Back	12.00	8.00	7.60
23.0201	Case for 2 Magazine Backs	12.00	8.00	7.60
20.1045	Filter, UV, 67mm	24.00	16.00	15.20
20.1041	Filter, Yellow, 67mm	24.00	16.00	15.20
20.1048	Filter, Skylight, 67mm	24.00	16.00	15.20
20.1049	Filter, 85B, 67mm	24.00	16.00	15.20
20.1035	Filter, UV, 60mm	20.00	13.33	12.66
20.1031	Filter, Yellow, 60mm	20.00	13.33	12.66
20.1032	Filter, Yellow, Green, 60mm	20.00	13.33	12.66
20.1033	Filter, Orange, 60mm	20.00	13.33	12.66
20.1034	Filter, Red, 60mm	20.00	13.33	12.66
20.1038	Filter, Skylight, 60mm	20.00	13.33	12.66
20.0716	Lens Shade, 60mm	4.50	3.00	2.85
20.0714	Lens Shade, 67mm	6.00	4.00	3.80

*Fair-traded in the State of New York

CONFIDENTIAL DEALER PRICE SCHEDULE

EFFECTIVE MARCH 1, 1968

ZEISS IKON
VOIGTLÄNDER

SECTION B—CONTAFLEX® 35mm

All items are in Order of Appearance in Catalog Pages

PAGE B-3	List	1-2 pc. net	3 and more pc. net	
23.2002	Leather Case	3.00	2.00	1.90
23.2003	Leather Case f/Lens Shade	4.50	3.00	2.85
20.1643	Intermediate Ring, 60-67mm	3.50	2.33	2.21
20.1011	Intermediate Ring, 49-60mm	3.50	2.33	2.21
20.1018	Intermediate Ring, 49-67mm	3.50	2.33	2.21
20.1620	Adapter Ring	4.50	3.00	2.85
20.1616	Connecting Ring	18.00	12.00	11.40
20.1025	Filter, UV, 27mm	7.50	5.00	4.75
20.1021	Filter, Yellow, 27mm	7.50	5.00	4.75
20.1022	Filter, Yellow Green, 27mm	7.50	5.00	4.75
20.1023	Filter, Orange, 27mm	7.50	5.00	4.75
20.1024	Filter, Red, 27mm	7.50	5.00	4.75
20.1028	Filter, Skylight, 27mm	7.50	5.00	4.75
20.1200	Contapol, 3x	19.50	13.00	12.35
20.0602	Lens Cap, front	1.00	.67	.64
20.0713	Lens Shade, 27mm	3.00	2.00	1.90
20.0800	Proxar 1x, 28.5mm	7.50	5.00	4.75
20.0801	Proxar 2x, 28.5mm	7.50	5.00	4.75
20.0802	Proxar 3x, 28.5mm	7.50	5.00	4.75
20.0803	Proxar 4x, 28.5mm	7.50	5.00	4.75
20.7070	Set of 4 Proxar lenses	30.00	19.00	—
20.7059	Case for 4 Proxars	2.50	1.67	1.59
20.0804	Proxar 10x, 27mm	15.00	10.00	9.50
20.1826	Table Clamp	18.00	12.00	11.40
20.1819	Pillar	18.00	12.00	11.40
20.1828	Connecting Arm	18.00	12.00	11.40
20.1824	Camera Adapter	18.00	12.00	11.40
PAGE B-4				
20.1810	T-Clamp	15.00	10.00	9.50
20.1820	Transverse Tube	15.00	10.00	9.50
20.1811	Clamp	15.00	10.00	9.50
20.1808	Tube	7.50	5.00	4.75
20.1813	Reflector	20.00	13.33	12.66
20.1812	Clamp	15.00	10.00	9.50
20.1614	Viewfinder, right-angle	36.00	24.00	22.80
20.1853	Reprophot	89.00	59.33	56.36
20.0300	Cassette	12.00	8.00	7.60
20.0001	Take-up Spool	1.00	.67	(3) .64
				(12) .58
20.0301	Core	1.00	.67	.64
20.0281	Cable Release	2.95	1.97	(3) 1.87
				(12) 1.67
23.0211	Neck Strap	1.95	1.30	1.23
20.0504	Eye Correction Lens	6.00	4.00	—
35.0207	Rubber Eye Cup	2.50	1.67	1.59
20.0203	Tripod Extension	9.00	6.00	5.70
65.0021	The Contaflex Guide	1.95	1.30	1.23

Item
Number

DESCRIPTION

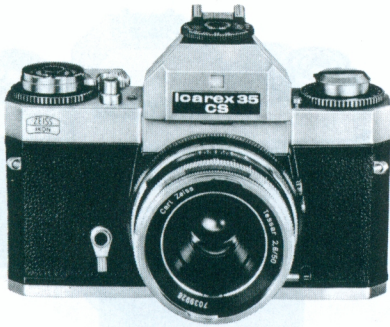

10.2300
11.2002



11.2005

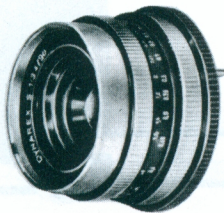

11.2004

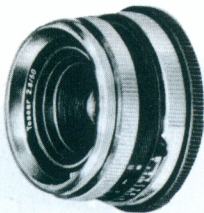

11.2002



20.1519



11.2003

March 1, 1968

ICAREX 35

35mm SLR camera with focal-plane shutter and fully interchangeable lenses.

- Focal-plane shutter, speeds from 1/2 to 1/1000 sec. plus B and selftimer.
- Interchangeable penta prism with or without CdS meter or waist-level viewfinders with interchangeable viewing screens.
- Instant-return mirror.
- M and X flash synchronization.
- Depth-of-field pre-view button.
- Instantly re-opening lens diaphragm.
- Automatically resetting frame counter.
- CdS meter uses PX 13 or PX 625 battery.

10.2300	ICAREX 35 CS, body only, incl. pentaprism with built-in CdS meter, full ground-glass with split-image indicator, lens and case extra	155.95
10.2300	Camera body as above }	199.95
11.2002	TESSAR f/2.8, 50mm }	
10.2300	Camera body as above }	189.95
11.2001	COLOR-PANTAR f/2.8, 50mm }	
10.2200	ICAREX 35, body only, incl. pentaprism viewfinder and full ground-glass with split-image indicator, lens and case extra	125.00
10.2200	Camera body as above }	169.00
11.2002	TESSAR f/2.8, 50mm }	
10.2200	Camera body as above }	159.00
11.2001	COLOR-PANTAR f/2.8, 50mm }	
10.2100	ICAREX 35, body only, incl. waist-level viewfinder and full ground-glass with split-image indicator, lens and case extra	105.00
10.2100	Camera body as above }	149.00
11.2002	TESSAR f/2.8, 50mm }	
10.2100	Camera body as above }	139.00
11.2001	COLOR-PANTAR f/2.8, 50mm }	
10.2000	ICAREX 35, stripped body, without viewfinder, without lens, case extra	93.00
23.0016	CASE, Eveready for Icarex 35	19.50

INTERCHANGEABLE LENSES

11.2002	TESSAR f/2.8, 50mm	44.00
11.2001	COLOR-PANTAR f/2.8, 50mm	34.00
11.2003	SKOPAREX f/3.4, 35mm	99.00
11.2004	DYNAREX f/3.4, 90mm	117.00
11.2005	SUPER-DYNAREX f/4, 135mm, with built-on lens shade	105.00
11.2008	SUPER-DYNAREX f/4, 200mm, with built-on lens shade	199.00
11.2010	TELOMAR f/5, 400mm, w/lens shade	296.00
11.2012	ZOOMAR f/2.8, 36-82mm	330.00
20.6605	FILTER ADAPTER RING for Zoomar lens	6.00
20.1629	MONOCULAR 8 x 30 B, 400mm, focal length	108.00
20.1644	ADAPTER for Monocular 8 x 30 B to fit over 50mm Color Pantar or Tessar lens	4.50
CLOSE-UP LENSES for Monocular 8 x 30 B		
20.0831	+ 1 dptr. lens, field: 2" x 3"	18.00
20.0832	+ 2 dptr. lens, field: 1 1/4" x 1 3/4"	21.00
20.0833	+ 3 dptr. lens, field: 3/4" x 1 1/4"	21.00
20.0834	+ 5 dptr. lens, field: 1/2" x 3/4"	39.00
20.0835	+ 8 dptr. lens, field: 1/4" x 1/2"	30.00

ICAREX 35 CAMERA SYSTEM

ZEISS IKON
VOIGTLÄNDER

DESCRIPTION

Item
Number

LENS SHADES

LENS SHADE, rubber 56mm screw-in mount for 35mm to 90mm lenses	4.50	20.0718
LENS SHADE, rubber, 95mm for Zoomar lens	12.00	20.5752

FILTERS

Bayonet mount, 50mm diameter for 35mm to 135mm lenses.

Yellow 2x	7.00	20.1051
Green 2x	7.00	20.1052
Orange 3x	7.00	20.1053
Red 8x	7.00	20.1054
UV 1x	7.00	20.1055
Skylight 1x	7.00	20.1058
CONTAPOL, polarizing filter 3x	30.00	20.1208

FILTERS

Screw-mount, 77mm, for 200mm lens

Yellow 3x	18.50	20.6041
Ultra-Violet 1x	18.50	20.6045
Skylight 1x	22.50	20.6048
CASE for one 77mm filter	3.00	23.7004

FILTERS

Screw-mount, 95mm, for Telomar and Zoomar lenses
(for Zoomar #20.6605 Filter adapter ring required)

Yellow 3x	28.00	20.6051
Orange 3x	28.00	20.6053
Ultra-violet 1x	28.00	20.6055

VIEWFINDER COMPONENTS

VIEWFINDER, pentaprism with CdS meter	62.95	20.1521
VIEWFINDER, pentaprism without meter	32.00	20.1520
VIEWFINDER, waist-level	12.00	20.1519
VIEWING SCREEN, clear-glass with cross-line reticule (not for viewfinder #20.1521)	9.00	20.1308
VIEWING SCREEN with split-image indicator, fresnel lens (not for viewfinder #20.1521)	9.00	20.1309

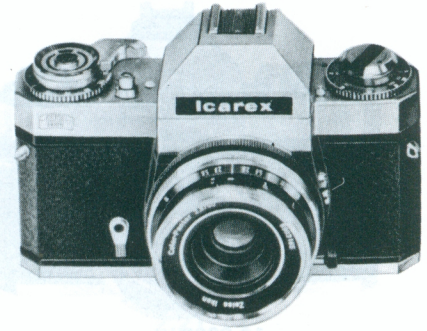

10.2200

11.2001



20.1521

Item
Number

DESCRIPTION

VIEWFINDER COMPONENTS (Cont'd)

20.1614	VIEWFINDER, right-angle	36.00
35.0207	RUBBER EYE CUP for viewfinder eye piece	2.50
20.0504	EYE-CORRECTION LENS (spherical only) from $\pm .5$ dptrs. to ± 5 dptrs in steps of 0.5 dptrs. (prescription required for ordering)	6.00

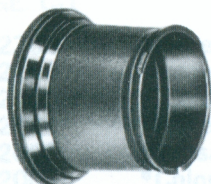

20.1640

CLOSE-UP ATTACHMENTS

For 35mm to 135mm lenses.

20.0846	CLOSE-UP LENS + 0.5 dptrs., 50mm bayonet-mount	8.00
20.0847	CLOSE-UP LENS + 1 dptrs., 50mm bayonet-mount	8.00
20.0848	CLOSE-UP LENS + 2 dptrs., 50mm bayonet-mount	8.00
20.0849	CLOSE-UP LENS + 3 dptrs., 50mm bayonet-mount	8.00
20.0850	CLOSE-UP LENS + 5 dptrs., 50mm bayonet-mount	8.00
For Zoomar f/2.8, 36-82mm lens (Adapter ring # 20.6605 required)		
20.5851	CLOSE-UP LENS + 1 dptr., 95mm screw-mount	28.00
20.5852	CLOSE-UP LENS + 2 dptrs., 95mm screw-mount	28.00
20.1640	EXTENSION TUBE 1:1 (for 35mm to 135mm lenses)	15.00
20.1647	EXTENSION TUBE 1:2 (for 35mm to 135mm lenses)	15.00
20.1630	FOCUSING BELLOWS ATTACHMENT	57.00
20.1646	MICRO ADAPTER for camera lens	18.00
20.1616	CONNECTING RING for microscope tube	18.00

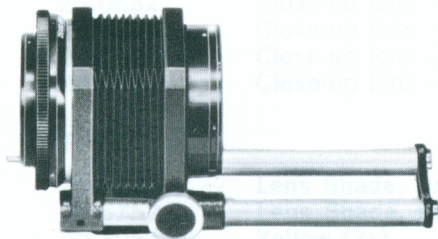

20.1630

SUNDRY ACCESSORIES

23.0207	CASE, carrying, universal	39.00
23.0211	NECK STRAP for camera	1.95
20.5210	NECK CHAIN for camera	6.00
23.1004	CASE, carrying for one 35mm, 50mm or 90mm lens with one filter or close-up lens	9.00
23.1005	CASE, carrying, for Super Dynarex 135mm with one filter or close-up lens	10.00
23.1203	CASE, carrying for Monocular 8 x 30 B	12.00
23.2006	CASE for waist-level or pentaprism viewfinder	4.50
23.2011	CASE for pentaprism with CdS meter	4.50
20.1853	REPROPHOT, copy stand	89.00
20.0205	ADAPTER for Reprophot (required for Icarex cameras)	3.00
20.0281	CABLE RELEASE, locking	2.95
23.2007	CASE for 3 filters or 3 close-up lenses	4.50
20.0630	LENS CAP, rear	1.00



20.1853

EXPOSURE METERS AND FLASHGUNS

SEE SECTION H

SECTION C — ICAREX 35

All items are in Order of Appearance in Catalog Pages

PAGE C-1		List	1-2 pc. net	3 and more pc. net
10.2300	*Icarex 35 body w/prism and meter . . .	155.95	103.97	98.77
10.2200	*Icarex 35 body w/prism	125.00	83.33	79.16
10.2100	*Icarex 35 body w/waist-level viewfinder	105.00	70.00	66.50
10.2000	*Icarex 35, stripped body	93.00	62.00	58.90
11.2002	*Tessar f/2.8	44.00	29.33	27.86
11.2001	*Color Pantar f/2.8	34.00	22.67	21.54
23.0016	*Case	19.50	13.00	12.35
11.2003	Skoparex f/3.4, 35mm	99.00	66.00	62.70
11.2004	Dynarex f/3.4, 90mm	117.00	78.00	74.10
11.2005	Super Dynarex f/4, 135mm	105.00	70.00	66.50
11.2008	Super Dynarex, 200mm	199.00	132.67	126.04
11.2010	Telomar, 400mm	296.00	197.33	—
11.2012	Zoomar f/2.8, 36-82mm	330.00	220.00	—
20.6605	Filter Adapter, Zoomar	6.00	4.00	3.80
20.1629	Monocular 8 x 30B	108.00	72.00	68.40
20.1644	Adapter for Monocular 8 x 30B	4.50	3.00	2.85
20.0831	Close-up lens + 1 dptr.	18.00	12.00	—
20.0832	Close-up lens + 2 dptr.	21.00	14.00	—
20.0833	Close-up lens + 3 dptr.	21.00	14.00	—
20.0834	Close-up lens + 5 dptr.	39.00	26.00	—
20.0835	Close-up lens + 8 dptr.	30.00	20.00	—
 PAGE C-2				
20.0718	Lens Shade, rubber, 56mm	4.50	3.00	2.85
20.5752	Lens Shade, rubber, 95mm	12.00	8.00	7.60
20.1051	Yellow (2x)	7.00	4.67	4.44
20.1052	Green (2x)	7.00	4.67	4.44
20.1053	Orange (3x)	7.00	4.67	4.44
20.1054	Red (8x)	7.00	4.67	4.44
20.1055	UV (1x)	7.00	4.67	4.44
20.1058	Skylight (1x)	7.00	4.67	4.44
20.1208	Contapol, polarizing filter (3x)	30.00	20.00	19.00
20.6041	Filter, 77mm, Yellow	18.50	12.33	11.71
20.6045	Filter, 77mm, UV	18.50	12.33	11.71
20.6048	Filter, 77mm, Skylight	22.50	15.00	14.25
23.7004	Case, 77mm filter	3.00	2.00	1.90
20.6051	Filter, 95mm, Yellow	28.00	18.67	17.74
20.6053	Filter, 95mm, Orange	28.00	18.67	17.74
20.6055	Filter, 95mm, UV	28.00	18.67	17.74
20.1521	Viewfinder, pentaprism w/meter	62.95	41.97	39.87
20.1520	Viewfinder, pentaprism	32.00	21.33	20.26
20.1519	Viewfinder, waist-level	12.00	8.00	7.60
20.1308	Viewing Screen, clear-glass w/cross-line reticule	9.00	6.00	5.70
20.1309	Viewing Screen	9.00	6.00	5.70

*Fair-traded in the State of New York

CONFIDENTIAL DEALER PRICE SCHEDULE

EFFECTIVE MARCH 1, 1968

ZEISS IKON
VOIGTLÄNDER

SECTION C — ICAREX 35

All items are in Order of Appearance in Catalog Pages

PAGE C-3		List	1-2 pc. net	3 and more pc. net
20.1614	Viewfinder, right-angle	36.00	24.00	22.80
35.0207	Rubber Eye Cup for viewfinder eyepiece	2.50	1.67	1.59
20.0504	Eye Correction Lens	6.00	4.00	—
20.0846	Close-up lens + 0.5 dptrs.	8.00	5.33	5.06
20.0847	Close-up lens + 1 dptrs.	8.00	5.33	5.06
20.0848	Close-up lens + 2 dptrs.	8.00	5.33	5.06
20.0849	Close-up lens + 3 dptrs.	8.00	5.33	5.06
20.0850	Close-up lens + 5 dptrs.	8.00	5.33	5.06
20.5851	Close-up lens + 1 dptr.	28.00	18.67	17.74
20.5852	Close-up lens + 2 dptrs.	28.00	18.67	17.74
20.1640	Extension Tube 1:1	15.00	10.00	9.50
20.1647	Extension Tube 1:2	15.00	10.00	9.50
20.1630	Focusing Bellows Attachment	57.00	38.00	36.10
20.1646	Micro Adapter f/camera lens	18.00	12.00	11.40
20.1616	Connecting Ring	18.00	12.00	11.40
23.0207	Case, carrying, universal	39.00	26.00	24.70
23.0211	Neck Strap f/camera	1.95	1.30	1.23
20.5210	Neck Chain f/camera	6.00	4.00	3.80
23.1004	Case, carrying	9.00	6.00	5.70
23.1005	Case, carrying	10.00	6.67	6.34
23.1203	Case, carrying, for M. 8 x 30B	12.00	8.00	7.60
23.2006	Case for waist-level or pentaprism viewfinder	4.50	3.00	2.85
23.2011	Case for CdS meter	4.50	3.00	2.85
20.1853	Reprophot, copy stand	89.00	59.33	56.36
20.0205	Adapter for Reprophot	3.00	2.00	1.90
20.0281	Cable Release, locking	2.95	1.97	(3) 1.87
				(12) 1.67
23.2007	Case for 3 filters	4.50	3.00	2.85
20.0630	Lens cap, rear	1.00	.67	.64

Supplement to ZIV Dealer Price List
Section C - Icarex 35 Camera System (Page C-1)
Effective October 1, 1968
New
ICAREX 35 S

35mm SLR camera with focal plane shutter with speeds from 1/2 to 1/1000 second plus B and self-timer; through-the-lens CdS metering.

Interchangeable lenses with convenient breech lock mounts (35mm to 400mm)

Pentaprism viewfinder with full ground-glass screen and split image rangefinder spot.

f/stops and exposure meter pointer visible in viewfinder; meter indication also on top of camera. Ready-to-shoot signal in viewfinder.
Meter interlocked with f/stop and shutter speed setting rings for convenient adjustments at eye-level or waist-level.

Instant-return mirror, instantly reopening diaphragm.

F and X flash synchronization.

Depth-of-field preview button with locking device.

Meter range: 25 - 1600 ASA - 1/2 second - 1/1000 second.

Automatically resetting frame counter.

Battery cut-off; CdS meter uses PX 13 or PX 625 battery.

Built-in dark slide in viewfinder.

Lenses and accessories supplied for Icarex 35 will fit Icarex 35 S with exception of waist-level/pentaprism viewfinders, interchangeable viewing screens and camera case.

10.3300	Icarex 35 S, body only	180.95
	case extra	
10.3300	Camera as above	
11.2014	Ultron f/1.8, 50mm	279.95
10.3300	Camera as above	
11.2002	Tessar f/2.8, 50mm	224.95

10.3300	Camera as above	214.95
11.2001	Pantar f/2.8, 50mm	
23.0016	Case, eveready for Icarex 35 S	19.50
	Interchangeable Lenses	
11.2014	Ultron f/1.8, 50mm	99.00
11.2002	Tessar f/2.8, 50mm	44.00
11.2001	Color-Pantar f/2.8, 50mm	34.00

Wide angle and telephoto lenses listed
on page C-1 dated March 1, 1968,
will also fit Icarex 35 S.

CONFIDENTIAL DEALER PRICE SCHEDULE
 EFFECTIVE OCTOBER 11, 1968
 SECTION C - ICAREX
 NEW ITEMS

		<u>List</u>	<u>1-2 pc net</u>	<u>3 and more pc net</u>
10.3300	*Icarex 35 S body w/prism and meter	180.95	120.63	114.60
11.2014	*Ultron f/1.8 50mm	99.00	66.00	62.70
11.2002	*Tessar f/2.8	44.00	29.33	27.86
11.2001	*Color Pantar f/2.8	34.00	22.67	21.54
23.0016	*Case	19.50	13.00	12.35

*Fair-traded in the State of New York

Item
Number

DESCRIPTION



10.1100
11.1102
11.1103

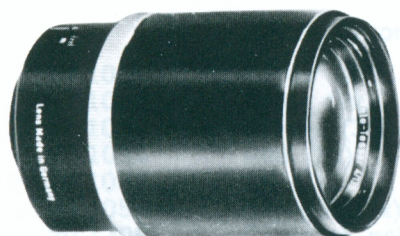

11.1105

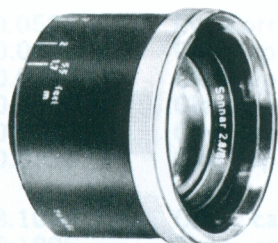

11.1104

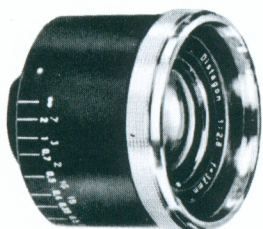

11.1101

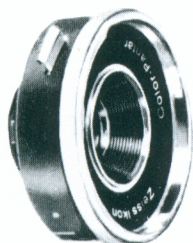

11.1102

CONTAFLEX® 126

- Fully automatic SLR camera using #126 instant-load cartridges.
- SLR camera using #126 instant-load cartridges.
- Built-in CdS exposure meter, with through-the-lens metering, which adjusts f/stop automatically. Battery: PX-13 or PX-625.
- Fully interchangeable lenses with bayonet mounts.
- Large and extra-bright penta prism viewfinder, with indication of f/stop in viewfinder. Fresnel type viewing screen with split-image rangefinder and ground-glass ring.
- Focal plane shutter speeds of 1/30 sec. to 1/500 sec.
- Automatic flash control with 32 and 45mm lenses — sets aperture as you focus.
- Synchronized for flashbulbs and strobe units.

10.1100	CONTAFLEX® 126, camera body only	139.95
10.1100	Camera body as above	
11.1102	COLOR-PANTAR f/2.8, 45mm }	159.95
10.1100	Camera body as above	
11.1103	TESSAR f/2.8, 45mm }	174.95
23.0015	CASE, Eveready	19.50

INTERCHANGEABLE LENSES

11.1101	DISTAGON f/2.8, 32mm	119.00
11.1102	COLOR-PANTAR f/2.8, 45mm	20.00
11.1103	TESSAR® f/2.8, 45mm	35.00
11.1104	SONNAR®, f/2.8, 85mm	99.95
11.1105	TELE-TESSAR®, f/4, 135mm w/built-on lens shade	99.00

LENS SHADE

20.0718	LENS SHADE, rubber 56mm screw-in mount for 32mm to 85mm lenses	4.50
---------	----------------------------------------------------------------------	------

FILTERS

Bayonet mount, 50mm diameter for 32mm to 135mm lenses.

20.1051	Yellow 2x	7.00
20.1052	Green 2x	7.00
20.1053	Orange 3x	7.00
20.1054	Red 8x	7.00
20.1055	UV 1x	7.00
20.1058	Skylight 1x	7.00
20.1208	CONTAPOL, polarizing filter 3x	30.00

VIEWFINDER COMPONENTS

20.1614	VIEWFINDER, right-angle	36.00
35.0207	RUBBER EYE CUP for viewfinder eye piece	2.50
20.0504	EYE-CORRECTION LENS (spherical only) from ± .5 dptrs to ± 5 dptrs in steps of 0.5 dptrs. (prescription required for ordering)	6.00

CLOSE-UP LENSES

bayonet mount, 50mm diameter

20.0846	CLOSE-UP LENS + 0.5 dptrs.	8.00
20.0847	CLOSE-UP LENS + 1 dptrs.	8.00
20.0848	CLOSE-UP LENS + 2 dptrs.	8.00
20.0849	CLOSE-UP LENS + 3 dptrs.	8.00
20.0850	CLOSE-UP LENS + 5 dptrs.	8.00

SUNDRY ACCESSORIES

23.1004	CASE, carrying for one 32mm, 45mm or 85mm lens with one filter or close-up lens	9.00
23.1005	CASE, carrying, for 135mm lens with one filter or close-up lens ..	12.00
23.2007	CASE, for 3 filters or 3 close-up lenses	4.50

CONFIDENTIAL DEALER PRICE SCHEDULE
EFFECTIVE MARCH 1, 1968

ZEISS IKON
VOIGTLANDER

SECTION D — CONTAFLEX® 126

All items are in Order of Appearance in Catalog Pages

PAGE D-1		List	1-2 pc. net	3 and more pc. net
10.1100	*Contaflex 126, body only	139.95	93.30	88.63
11.1102	*Color Pantar f/2.8	20.00	13.33	12.66
11.1103	*Tessar f/2.8	35.00	23.33	22.16
23.0015	*Case	19.50	13.00	12.35
11.1101	Distagon f/2.8, 32mm	119.00	79.33	75.36
11.1104	Sonnar f/2.8, 85mm	99.95	66.63	63.30
11.1105	Tele-Tessar f/4, 135mm	99.00	66.00	62.70
20.0718	Lens Shade, rubber, 56mm	4.50	3.00	2.85
	Filters, bayonet mount, 50mm			
20.1051	Yellow (2x)	7.00	4.67	4.44
20.1052	Green (2x)	7.00	4.67	4.44
20.1053	Orange (3x)	7.00	4.67	4.44
20.1054	Red (8x)	7.00	4.67	4.44
20.1055	UV (1x)	7.00	4.67	4.44
20.1058	Skylight (1x)	7.00	4.67	4.44
20.1208	Contapol, polarizing filter (3x)	30.00	20.00	19.00
20.1614	Viewfinder, right-angle	36.00	24.00	22.80
35.0207	Rubber Eye Cup for viewfinder eyepiece	2.50	1.67	1.59
20.0504	Eye Correction Lens	6.00	4.00	—
20.0846	Close-up lens + 0.5 dptrs.	8.00	5.33	5.06
20.0847	Close-up lens + 1 dptrs.	8.00	5.33	5.06
20.0848	Close-up lens + 2 dptrs.	8.00	5.33	5.06
20.0849	Close-up lens + 3 dptrs.	8.00	5.33	5.06
20.0850	Close-up lens + 5 dptrs.	8.00	5.33	5.06
23.1004	Case, carrying	9.00	6.00	5.70
23.1005	Case, carrying	10.00	6.67	6.34
23.2007	Case, carrying for 3 filters	4.50	3.00	2.85

*Fair-traded in the State of New York

Item
Number

DESCRIPTION

VITESSA

- New 35mm pocket-size camera with modern slim-line styling.
- Equipped with Voigtlander Color-Lanthar f/2.8, 42mm lens, offering amazing wide angle field coverage and increased depth of field.
- Focusing by zone focusing symbols visible in viewfinder, also complete footage scale on lens mount.

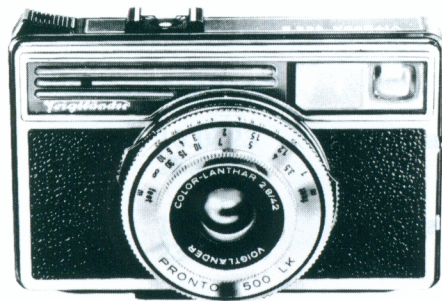

10.0423

MODEL 500 S

- Built-in match-needle CdS exposure meter, interlocked with shutter speeds and f/stops. f/stops visible in viewfinder. Provisions for dull weather/backlighting compensation. Battery: PX-13 or PX-625. Built-in battery tester.
- Extra-bright viewfinder with luminous frame. f/stop scale, zone focusing symbols and exposure meter pointer also visible in viewfinder.
- X-type flash synchronization with hot shoe contacts suitable for flash bulbs and strobe units.

MODEL 500 AE

- Features built-in CdS meter, which electronically controls transistorized Prontor 500 electronic shutter. Provides continuous and instantaneous adjustments over entire range from 10 sec. to 1/500 sec.
- Indication of f/stop, zone focusing symbols and snapshot speeds (1/30 to 1/500 sec.) in viewfinder, including slow speed warning signal.
- Unique type of flash automation.
- Model 500 AE operates on two PX-825 or equivalent batteries. (Not incl.)

Other important Vitessa features:

- Automatically resetting frame counter.
- Special red-white indicator signalling proper threading of film through camera.
- Camera controls conveniently located on camera body.
- Enlarged shutter release, easy to operate with gloves or mittens.

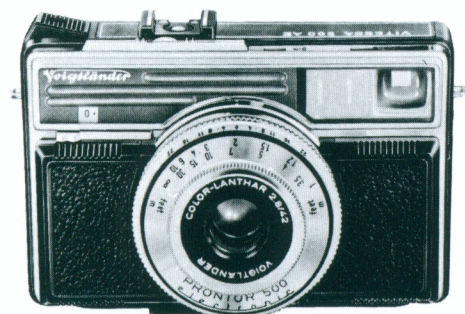

10.0413

10.0423	VITESSA 500 S with Color-Lanthar f/2.8, 42mm in Prontor 500 LK shutter, speeds 1/15 to 1/500 sec. plus B and selftimer. Case extra	89.95
23.8007	CASE, eveready	12.00
10.0413	VITESSA 500 AE with Color-Lanthar f/2.8, 42mm in Prontor electronic shutter, speeds 10 sec. to 1/500 sec., case extra	109.95
23.8009	CASE, eveready	12.00
20.5702	LENS SHADE, rubber, 30.5mm, screw-in	3.00
	FILTERS, 30.5mm, screw-in	5.00
20.6000	Yellow	
20.6002	Green	
20.6003	Orange	
20.6005	UV	
20.6008	Skylight	
20.5801	CLOSE-UP LENSES, 30.5mm screw-in 1x, f = 1m (for distances 40"—20")	6.00
20.5802	2x, f = 0.5m (for distances 20"—12")	6.00

CONFIDENTIAL DEALER PRICE SCHEDULE

EFFECTIVE MARCH 1, 1968

ZEISS IKON VOIGTLANDER

SECTION E — 35mm VIEWFINDER CAMERAS

All items are in Order of Appearance in Catalog Pages

PAGE E-1		List	1-2 pc. net	3 and more pc. net
10.0423	Vitessa 500 S	89.95	59.97	56.97
23.8007	Case	12.00	8.00	7.60
10.0413	Vitessa 500 AE	109.95	73.30	69.63
23.8009	Case	12.00	8.00	7.60
20.5702	Lens shade, 30.5mm	2.50	1.67	1.59
20.6000	Filter, 30.5mm Yellow	5.00	3.33	3.16
20.6002	Filter, 30.5mm Green	5.00	3.33	3.16
20.6003	Filter, 30.5mm Orange	5.00	3.33	3.16
20.6005	Filter, 30.5mm UV	5.00	3.33	3.16
20.6008	Filter, 30.5mm Skylight	5.00	3.33	3.16
20.5801	Close-up lens 1x	6.00	4.00	3.80
20.5802	Close-up lens 2x	6.00	4.00	3.80

Item
Number

DESCRIPTION

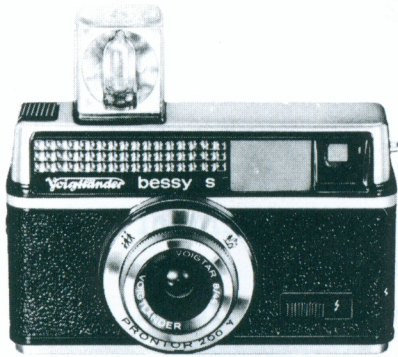

10.0021

BESSY S CAMERA

Low cost, compact camera designed for instant-loading #126 (Kodapak) cartridges.

- Coated Voigtar f/8, 44mm lens with zone focusing symbols; near zone: 5-16 feet — distant zone: over 16 feet.
- Prontor 200V shutter — 1/200 sec. for outdoor — 1/30 sec. for flash.
- Built-in flash cube adapter with automatic advance mechanism.
- Extra-bright frame viewfinder with parallax correction marks.

10.0021

BESSY S CAMERA 29.95

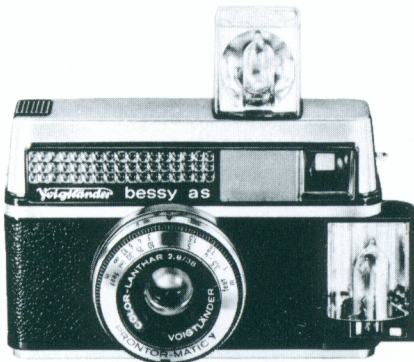

10.0013

BESSY AS CAMERA

Full feature Kodapak loading camera with electric-eye exposure control.

- Built-in flash cube adapter.
- Built-in two position AG-1/AG-3 flashgun.
- 38mm f/2.8 Color-Lanthar-Lens.
- Shutter automatically sets to 1/30 sec. when flash unit is in position.
- Range control distance setting in viewfinder.
- Aperture and distance are coupled for fully automatic flash control.
- Flash unit can also be used as bounce unit and aperture automatically adjusts for bounce flash.
- Prontor-matic V shutter with 1/30 sec. for flash and 1/125 sec. for outdoor use.
- Red-Green signal in viewfinder warns if light is insufficient.
- Automatic Parallax correction.

10.0013

BESSY AS CAMERA 69.95

23.8011

BESSY CASE 7.50

23.8012

BESSY POUCH 3.60

CONFIDENTIAL DEALER PRICE SCHEDULE

EFFECTIVE MARCH 1, 1968

ZEISS IKON
VOIGTLÄNDER

SECTION F — #126 VIEWFINDER CAMERAS

All items are in Order of Appearance in Catalog Pages

PAGE F-1		List	1-5 pc. net	6-11 pc. net	12 and more pc. net
10.0021	Bessy S	29.95	19.97	18.97	17.97
10.0013	Bessy AS	69.95	46.63	44.30	41.97
23.8011	Bessy Case	7.50	5.00	4.75	4.50
23.8012	Bessy Pouch	3.60	2.40	2.28	2.16

Supplement to ZIV Dealer Price List
Section F - #126 Viewfinder Cameras
New
Vitessa 126 CS

Easy-to-use compact camera designed for #126 cartridges, featuring automatic exposure control in viewfinder.

Coated Voigtar f/8, 44mm lens with zone focusing symbols: near zone: 5-16 feet, distant zone: over 16 feet.

Prontor shutter - 1/125 sec. for outdoor - 1/40 sec. for flash or in daylight.

Red signal in viewfinder warns against insufficient light at either shutter speed.

Two-stage shutter release: activate CdS meter-release shutter.

Flash cube adapter with built-in capacitor (BC) with automatic advance mechanism.

Extra-bright frame viewfinder with parallax correction marks.

Battery PX-21, 4.5 volt required.

10.0041 Vitessa 126 CS without battery, case extra \$39.95.

Vitessa 126 electronic

Compact snapshot camera with electronic exposure control, designed for instant-loading #126 cartridges.

Novar f/6.3, 40mm in Prontor 300 electronic shutter, zone focusing symbols; near zone 5-16 feet, distant zone over 16 feet.

CdS meter electronically controls full range of shutter speeds (1/300-10 seconds)

Choice of two lens apertures (f/6.3 or f/11) depending on available light.

Red light in viewfinder signals shutter speed slower than 1/30 sec.

Two-stage shutter release: activate CdS meter - release shutter.

Flash cube adapter with built-in capacitor (BC) with automatic advance mechanism.

Extra-bright frame viewfinder with parallax correction marks.

Battery PX-21, 4.5 volts required.

10.0051 Vitessa 126 electronic without battery,
case extra.....\$59.95

23.8013 Case, carrying for Vitessa 126 CS or 126 E.....\$ 8.00

23.8012 Zipper pouch for Vitessa 126 CS, 126 E or
former Bessy \$ 7.50

Part No.	Description	Price
10.0051	Vitessa 126 electronic without battery, case extra.....	\$59.95
23.8013	Case, carrying for Vitessa 126 CS or 126 E.....	\$ 8.00
23.8012	Zipper pouch for Vitessa 126 CS, 126 E or former Bessy	\$ 7.50



CONFIDENTIAL DEALER PRICE SCHEDULE
EFFECTIVE OCTOBER 1, 1968

SECTION F - #126 VIEWFINDER CAMERAS
NEW ITEMS

		<u>List</u>	<u>1-5 pc</u> <u>net</u>	<u>6-11 pc</u> <u>net</u>	<u>12 and more</u> <u>pc net</u>
10.0041	Vitessa 126 CS.....	39.95	26.63	25.30	23.97
10.0051	Vitessa 126 E.....	59.95	39.97	37.97	35.97
23.8013	Case, Carrying.....	8.00	5.33	5.06	4.80
23.8012	Zipper pouch.....	3.60	2.40	2.28	2.16

Item
Number

DESCRIPTION

MOVIFLEX S 8

Fully electric reflex movie camera.

- Zeiss Vario-Sonnar f/1.9, 9 to 36mm with complete manual control for special effects.
- Electronic exposure adjustment without conventional instrument, consisting of a bridge circuit with CdS photo resistor and servo motor which opens and closes iris diaphragm (through-the-lens metering).
- Zone focusing, symbols visible in viewfinder.
- Yellow/Red warning lights against insufficient light and end of film.
- Speeds: 18 and 24 fps plus single frame.
- Apertures: f/1.9 to f/45 — no grey filter required.
- Extra-bright, flicker-free reflex viewfinder with rubber eye cup and built-in eye correction (± 5 diopters).
- Built-in color film conversion filter.
- Uses 4 penlight batteries, 1.5 volts.



34.1005

34.1005	MOVIFLEX S 8 with Zeiss Vario-Sonnar f/1.9/9-36mm, rubber eye-cup and carrying strap, w/o batteries, carrying case extra	279.50
23.3203	CASE , Carrying for Moviflex S 8	18.00
23.3202	UNIVERSAL CARRYING CASE	39.00
35.0704	LENS SHADE , 56mm bayonet mount	6.00
	FILTERS , 56mm bayonet mount	
20.1065	Ultra Violet 1x	19.50
20.1068	Skylight 1x	19.50
	CLOSE-UP LENSES , 56mm, bayonet mount.	
20.0843	+ 1 dptr.	18.00
20.0844	+ 2 dptrs.	18.00
20.0845	+ 3 dptrs.	18.00
20.0840	+ 5 dptrs.	18.00
35.1810	COMPENDIUM with right-angle mirror	21.00
20.0281	CABLE RELEASE , locking	2.95

MOVILUX S 8*

8mm movie projector for Super 8 film. (400 feet reel capacity.)

- Sharp Zeiss projection lens.
- High-intensity 12 volt/100 watts Halogen lamp with interference cold light mirror. High/low switch.
- Push-button control — forward, reverse and still.
- 18 and 24 fps plus still.
- Automatic motor stop at end of reel or when film breaks.
- Automatic frame adjustment, when switching from forward to backward projection.
- Automatic threading, film can easily be removed in mid-roll.
- Adjustable voltage selection — 110-240 volts, 50-60 cycles.



36.0081

36.0081	MOVILUX S 8 w/P-Planar f/1.2, 18mm, Halogen lamp 12V/100W and connecting cord, case extra	169.95
36.0082	MOVILUX S 8 w/Vario-P-Sonnar f/1.4, 15-25mm lens, otherwise same as above, case extra	189.95
36.7702	CARRYING CASE for projector	15.00

MOVILUX DS 8*

Same specifications as Movilux S 8, but convertible to super 8, double 8 and single 8 films.

36.0091	MOVILUX DS 8 w/P-Planar f/1.2, 18mm, Halogen lamp 12V/100W and connecting cord, case extra	189.95
36.0092	MOVILUX DS 8 w/Vario-P-Sonnar f/1.4, 15-25mm lens, otherwise same as above, case extra	209.95
36.7702	CARRYING CASE for projector	15.00

ACCESSORIES

38.6032	HALOGEN LAMP , 12 Volts/100 Watts	9.00
36.7702	CARRYING CASE for projector	15.00
36.5517	400 foot reel	4.50

*Sold only with case, which is required to set up projector.

MOVIE & PROJECTION EQUIPMENT

**ZEISS IKON
VOIGTLANDER**

DESCRIPTION

**Item
Number**

PERKEO AF AUTOMAT

Fully automatic 2" x 2" Slide Projector with automatic focusing, remote control operation forward-reverse, automatic timer, 5-30 seconds. Uses extra-bright Halogen lamp 24 volts/150 watts, fan-cooled, high-low switch, aspherical condenser system, adjustable voltage selector 110/240 volts.

PERKEO AF AUTOMAT, with Talon f/2.8, 100mm lens, Halogen lamp 24 volts 150 watts, connecting cord, remote control, one slide tray (36's), carrying case extra **189.95**

CARRYING CASE, for projector **15.00**

38.2138
38.7763

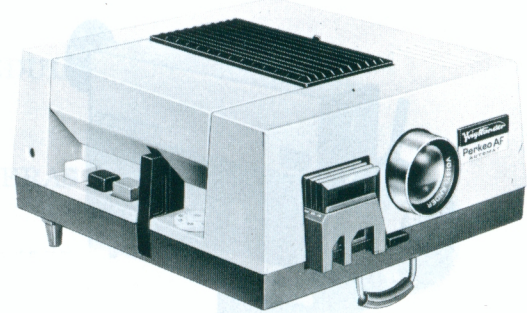

38.2138

PERKEO AUTOMAT J 150

Automatic 2" x 2" slide projector, focusing and slide changing forward-reverse by remote control. Uses extra bright Halogen lamp 24 volts/150 watts, fan-cooled, high-low switch, adjustable voltage selector 110/240 volts.

PERKEO AUTOMAT J 150 automatic slide projector, with Talon f/2.8, 100mm lens, remote control, connecting cord, one slide tray holding 36 slides, one Halogen lamp 24 volts/150 watts, case extra **160.00**

CARRYING CASE, for projector **15.00**

38.2128
38.7763

PERKEO AUTOMAT J

Same features as Perkeo Automat J 150 except for Halogen lamp 12 volts/100 watts.

PERKEO AUTOMAT J, automatic 2" x 2" slide projector, focusing and slide changing forward-reverse by remote control. With bright Halogen lamp 12 volts/100 watts, fan-cooled, high-low switch, adjustable voltage selector 110/240 volts, carrying case extra **134.95**

CARRYING CASE, for projector **15.00**

38.2118
38.7763

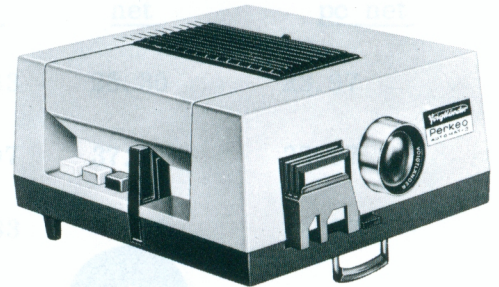

38.2152

PERKEO J 50 S AUTOMAT

Automatic 2" x 2" slide projector, extremely compact and light-weight, slide changing and focusing by remote control. Uses bright Halogen lamp 12 volts/50 watts, fan-cooled, built-on carrying handle.

PERKEO J 50 S AUTOMAT with Talon f/2.8, 100mm lens, Halogen lamp 12 volts/50 watts, connecting cord, remote control, one slide tray 36's, carrying bag extra **109.95**

CARRYING BAG, for projector **3.00**

TWO SLIDE TRAYS, holding 36 slides each in plastic container ... **3.50**

TWO SLIDE TRAYS, holding 50 slides each in plastic container ... **5.70**

HALOGEN LAMP, 24 volts/150 watts **10.00**

HALOGEN LAMP, 12 volts/100 watts **9.00**

HALOGEN LAMP, 12 volts/50 watts **7.50**

38.2152
38.7765
38.5604
38.5605
38.6101
38.6100
38.6110

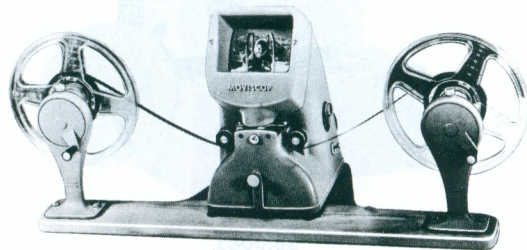

36.2513

INTERCHANGEABLE LENSES for Perkeo Automat Projectors

Talon f/2.8, 50mm **34.00**

Talon f/2.9, 85mm **27.65**

Talon f/2.8, 100mm **34.00**

Talon f/3.0, 125mm **42.50**

P-Planar f/2.5, 90mm **59.50**

38.5064
38.5061
38.5062
38.5063
38.5070

MOVISCOP EDITORS

Moviscop Viewer and Editor for 16mm film, with rewinds and baseboard **169.00**

Moviscop Viewer and Editor for 16mm film, without baseboard and without rewinds **139.00**

Spare Lamp for Moviscop **2.25**

36.2513
36.2512
36.6002

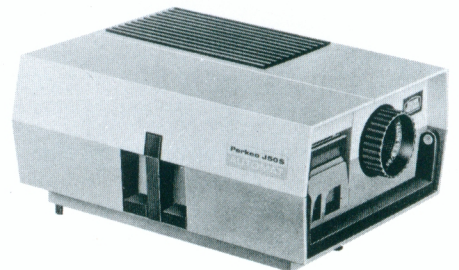

38.2152

Supplement to ZIV - Dealer Price List

Section Movie and Projection Equipment (Page G-1)
Effective October 1, 1968

NEW

MOVIFLEX MS 8

Fully electric reflex movie camera for super 8 cartridges.

Special Features:

Zeiss Vario-Sonnar f/1.9, 9 to 36mm power zoom with optional manual control.

Focusing range: 5 feet - infinity.

Electronic exposure adjustment without conventional instrument, consisting of a bridge circuit with CdS photo resistor and servo motor which opens and closes iris diaphragm (through-the-lens metering).

Built-in micro-prism spot rangefinder.

Provisions for completely manual override of meter.

One lens stop override for backlighted scenes.

Motorized fading device.

Two-stage shutter release: Activation of exposure meter - continuous film run.

Yellow/red warning lights against insufficient light and end of film.

Speeds: 18 and 24 fps plus single frame.

Apertures: f/1.9 to f/45 - no grey filter required.

Extra-bright, flicker-free reflex viewfinder with rubber eye cup and built-in eye correction (± 5 diopters).

Built-in color film conversion filter.

Uses 4 penlight batteries, 1.5 volts (size AA): built-in battery tester.

MOVIFLEX MS 8 with Zeiss Vario-Sonnar f/1.9/9-36mm, rubber eye-cup and carrying strap, w/o batteries, carrying case extra..... \$279.50
34.1007

UNIVERSAL CARRYING CASE..... \$ 39.00
23.3202

Price Reduction

34.1005 MOVIFLEX S 8 with manual Zeiss Vario-Sonnar f/1.9/9-36mm, rubber eye-cup and carrying strap, w/o batteries, carrying case extra..... \$249.50

23.3202 UNIVERSAL CARRYING CASE..... \$ 39.00

CONFIDENTIAL DEALER PRICE SCHEDULE
EFFECTIVE OCTOBER 1, 1968

SECTION G - MOVIE & PROJECTION EQUIPMENT
NEW ITEMS

		<u>List</u>	<u>1-2 pc net</u>	<u>3 and more pc net</u>
34.1007	Moviflex MS 8	279.50	186.33	177.01
23.3202	Case universal	39.00	36.00	24.70
34.1005	Moviflex S 8	249.50	166.33	158.01
23.3202	Case universal	39.00	26.00	24.70

Item
Number

DESCRIPTION

FLASHGUNS, BULB

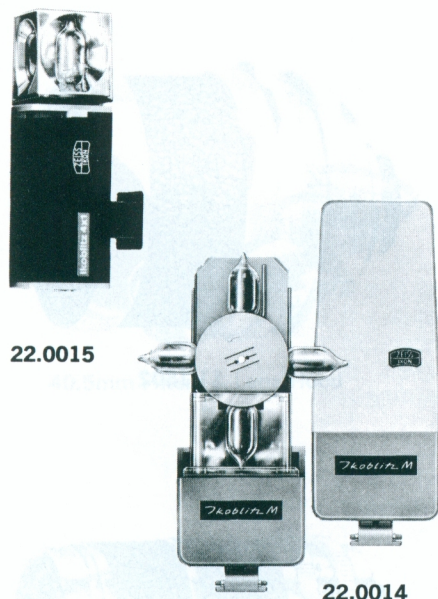

22.0015

22.0014

22.0016	IKOBLITZ 4 x 1, with PC flash cord, flash cube holder, BC unit for standard flash cubes, direct or bounce flash, uses 15 volt battery (battery not included), in plastic case	7.95
22.0015	IKOBLITZ 4 x 1, without cord, with center pin contact, for hot shoe cameras, flash cube holder, otherwise same features as 22.0016	7.95
22.0014	IKOBLITZ M with PC cord, accepts four AG-1 or AG-3 bulbs for rapid sequence shots. Uses 15-volt battery (battery not included).	12.95
22.0008	IKOBLITZ 6 SPECIAL, direct-contact (cordless) type. BC flash unit for AG-1 and AG-3 bulbs. For 15-volt battery (battery not included). For Contaflex Super BC and super	12.95
22.0061	AG-1 flash gun with PC cord contact for most cameras	4.25

EXPOSURE METERS

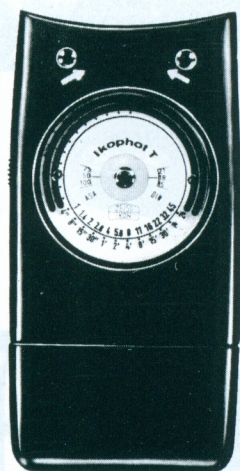

21.2003

21.2003	IKOPHOT T— Fully transistorized, Cds exposure meter with bridge circuit. No moving coil or needle. Exposure indication by three signal lights. Uses 9 volt transistor battery. Reading ranges: 1/1000 sec. to 2 hours. 8 fps to 128 fps 6 ASA to 3200 ASA 9 DIN to 36 DIN	64.95
21.2002	IKOPHOT S, photo-electric exposure meter, complying with ASA specifications calibrated in shutter and cine speeds, plus exposure values (EV) for reflected light readings, small compact design for instant one-hand operation, complete with wrist chain and leather case	17.95
21.2001	IKOPHOT CD, super-sensitive Cds meter for reflected and incident light readings, complying with ASA specifications, calibrated in shutter and cine speeds, plus exposure values (EV), small compact design for instant one-hand operation, complete with wrist chain and leather case	34.95
21.2061	Slip-on exposure meter with case. Slips into accessory shoe on camera. Selenium cell meter — reads 1 to 1/500 sec. f/2 to f/22 — ASA 12-1600	12.95

RANGEFINDERS

20.6501	Rangefinder — in feet	9.00
20.6502	Rangefinder — in meters	9.00
23.7031	Case for Rangefinder	1.75
20.5210	Chrome neck chain for all cameras with attachment lugs on camera body	6.00

CAMERA ACCESSORIES

ZEISS IKON
VOIGTLANDER

DESCRIPTION

Item
Number

Lenses and Accessories for Ultramatic CS, Bessamatic M and Bessamatic Deluxe Cameras.

Skoparex® 35mm f/3.4 wide angle lens. Angle of view: 63°. Focusing range: From infinity to 39". Six elements	96.00	11.1501
Case for Skoparex. (Sold only with case)	6.50	23.6001
Skopagon® 40mm f/2.0 sem-wide angle lens Angle of view: 58°. Focusing range: From infinity to 35". Nine elements	179.00	11.1502
Case for Skopagon. (Sold only with case)	7.50	23.6002
Dynarex® 90mm f/3.4 telephoto lens. Angle of view: 28°. Focusing range: From infinity to 6½ feet. Five elements	114.00	11.1507
Case for Dynarex. (Sold only with case)	6.50	23.6005
Super-Dynarex® 135mm f/4.0 telephoto lens. Angle of view: 19°. Focusing range: From infinity to 13 feet. Four elements	105.00	11.1508
Case for Super-Dynarex 135mm (Sold only with case)	9.00	23.6008
Super-Dynarex® 200mm f/4.0 telephoto lens. Angle of view: 12.5°. Focusing range: From infinity to 28 feet. Five elements	214.50	11.1509
Case for Super-Dynarex 200mm. (Sold only with case)	12.50	23.6009
Super-Dynarex® 350mm f/5.6 telephoto lens. Angle of view: 7°. Focusing range: From infinity to 83 feet. Seven elements	299.50	11.1510
Case for Super-Dynarex 350mm telephoto. (Sold only with case)	18.00	23.6010
Color-Skopar® 50mm f/2.8 lens. Angle of view: 48°. Focusing range: From infinity to 39". Four elements	48.00	11.1504
Septon® 50mm f/2.0 lens. Angle of view: 48°. Focusing range: From infinity to 35". Seven elements	104.00	11.1505
Voigtlander-Zoomar 36mm to 82mm f/2.8 zoom lens. Angle of view: 30° to 62°. Focusing range: From infinity to 4½ feet. Fourteen elements. For Bessamatic Deluxe, Bessamatic m and Ultramatic	290.00	11.1506
Case for Zoomar Lens	12.00	23.6006

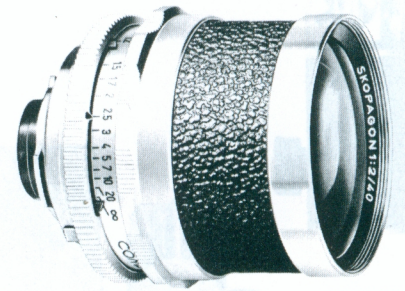

11.1502

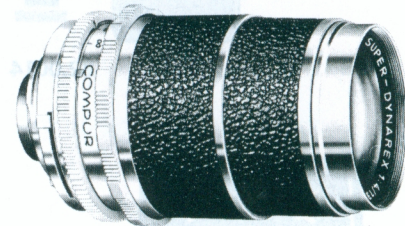

11.1508



11.1510



11.1505

40.5mm Filters, Focar Lenses and Lens Hoods for Skoparex, Color-Lanthar, Color-Skopar, 90mm Dynarex and 135mm Super-Dynarex Lenses.

Light Yellow Filter	6.00	20.6020
Medium Yellow Filter	6.00	20.6021
Green Filter	6.00	20.6022
Orange Filter	6.00	20.6023

CAMERA ACCESSORIES

ZEISS IKON
VOIGTLANDER

DESCRIPTION

Item
Number

Cases and Other Accessories for Voigtlander Bessamatic, Bessamatic M and Ultramatic Cameras.

Tripod adapter for Ultramatic or Bessamatic cameras. Provides better camera balance when using Voigtlander-Zoomar lens or long telephoto lenses	7.50	20.5031
Spare accessory shoe for Bessamatic, Bessamatic m or Ultramatic cameras	1.90	20.5001
Microscope adapter for Bessamatic or Ultramatic cameras	7.50	20.6621
Connecting ring for microscope adapter to Color-Skopar or Color-Lanthar lenses. 41mm	1.50	20.6602
Connecting ring for microscope adapter to Septon or Skopagon lenses. 54mm	2.00	20.6603
Focusing attachment for micro-photography. Provides full field, fine focusing control for microscope photography	50.00	20.6622
Right angle viewfinder for Bessamatic or Ultramatic. Allows easier viewing position for micro-photography or close-up work	30.00	20.6520
Camera sling for Bessamatic or Bessamatic m	7.50	23.8028
Camera sling for Ultramatic	6.50	23.8038
Holster case for Bessamatic or Ultramatic with Voigtlander-Zoomar lens attached. Holds camera in camera sling for instant use	26.50	23.8027
Light Cap for Ultramatic CS viewfinder60	20.6522
Rubber Eye Cup for viewfinder	2.50	20.6521

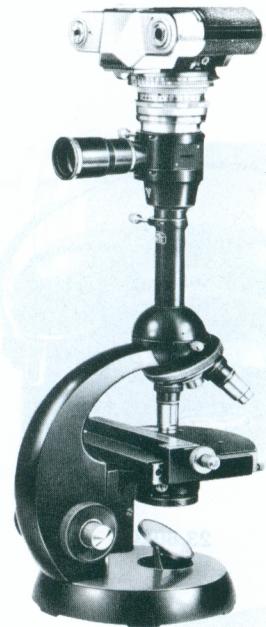

Micro Unit

CONFIDENTIAL DEALER PRICE SCHEDULE

EFFECTIVE MARCH 1, 1968

ZEISS IKON
VOIGTLANDER

SECTION H — CAMERA ACCESSORIES

All items are in Order of Appearance in Catalog Pages

PAGE H-1		List	1 pc. net	3 pc. net	12 pc. net
22.0016	Ikoblitz 4 x 1, cord	7.95	5.30	5.04	3.98
22.0015	Ikoblitz 4 x 1, pin contact	7.95	5.30	5.04	3.98
22.0014	Ikoblitz M, cord	12.95	8.63	8.20	6.48
22.0008	Ikoblitz 6, Special	12.95	8.63	8.20	6.48
22.0061	AG-1 flashgun, cord	4.25	2.83	2.69	2.55
21.2003	Ikophot T	64.95	43.30	41.14	36.80
21.2002	Ikophot S	17.95	11.97	11.37	10.17
21.2001	Ikophot CD	34.95	23.30	22.13	19.80
21.2061	Slip-on exposure meter	12.95	8.63	8.20	7.34
20.6501	Rangefinder, feet	9.00	6.00	5.70	—
20.6502	Rangefinder, meter	9.00	6.00	5.70	—
23.7031	Case for rangefinder	1.75	1.17	1.11	—
20.5210	Neck Chain	6.00	4.00	3.80	—

PAGE H-2		List	1-2 pc. net	3 and more pc. net
11.1501	Skoparex, f/3.4, 35mm	96.00	64.00	60.80
23.6001	Case	6.50	4.33	4.11
11.1502	Skopagon, f/2, 40mm	179.00	119.33	113.36
23.6002	Case	7.50	5.00	4.75
11.1507	Dynarex, f/3.4, 90mm	114.00	76.00	72.20
23.6005	Case	6.50	4.33	4.11
11.1508	Super-Dynarex, f/4, 135mm	105.00	70.00	66.50
23.6008	Case	9.00	6.00	5.70
11.1509	Super-Dynarex, f/4, 200mm	214.50	143.00	135.85
23.6009	Case	12.50	8.33	7.91
11.1510	Super-Dynarex, f/5.6, 350mm	299.50	199.67	—
23.6010	Case	18.00	12.00	—
11.1504	Color-Skopar, f/2.8, 50mm	48.00	32.00	30.40
11.1505	Septon, f/2, 50mm	104.00	69.33	65.86
11.1506	Voigtlander-Zoomar f/2.8, 36 to 82mm	290.00	193.33	—
23.6006	Case for Zoomar	12.00	8.00	7.60
20.6020	Light Yellow filter, 40.5mm	6.00	4.00	3.80
20.6021	Medium Yellow filter, 40.5mm	6.00	4.00	3.80
20.6022	Green filter, 40.5mm	6.00	4.00	3.80
20.6023	Orange filter, 40.5mm	6.00	4.00	3.80

CONFIDENTIAL DEALER PRICE SCHEDULE

EFFECTIVE MARCH 1, 1968

ZEISS IKON
VOIGTLANDER

SECTION H — CAMERA ACCESSORIES

All items are in Order of Appearance in Catalog Pages

PAGE H-3	List	1-2 pc. net	3 and more pc. net	
20.6025	Haze UV filter, 40.5mm	6.00	4.00	3.80
20.6201	Polarizing filter, 42mm	20.00	13.33	12.66
20.6028	Skylight filter, 40.5mm	7.50	5.00	4.75
20.5821	Focar A +1 close-up lens, 40.5mm	7.50	5.00	4.75
20.5822	Focar B +2 close-up lens, 40.5mm	7.50	5.00	4.75
20.5823	Focar C +3.5 close-up lens, 40.5mm	7.50	5.00	4.75
20.5824	Focar D +6.5 close-up lens, 40.5mm	7.50	5.00	4.75
20.6203	Portrait attachment for 135mm Super-Dynarex	8.00	5.33	5.06
20.5825	Focar 0 close-up lens for 90mm Dynarex and 135mm Super-Dynarex lenses	6.00	4.00	3.80
20.5720	Lens hood for 50mm f/2.8, 90mm and 135mm lenses	3.10	2.07	1.97
20.5713	Mask for #20.5720 lens hood for 90mm and 135mm lenses	1.30	.87	.83
20.5760	Lens hood for Skoparex 35mm lens	3.10	2.07	1.97
23.7002	Case for filters and lens hood — 40.5mm	4.50	3.00	2.85
20.6030	Light Yellow filter, 54mm	9.35	6.23	5.92
20.6031	Medium Yellow filter, 54mm	9.35	6.23	5.92
20.6032	Green filter, 54mm	9.35	6.23	5.92
20.6033	Orange filter, 54mm	9.35	6.23	5.92
20.6035	Haze UV filter, 54mm	9.35	6.23	5.92
20.6202	Polarizing filter, 54mm	21.00	14.00	13.30
20.6038	Skylight filter, 54mm	15.00	10.00	9.50
20.5831	Focar A +1 close-up lens, 54mm	9.35	6.23	5.92
20.5832	Focar B +2 close-up lens, 54mm	9.35	6.23	5.92
20.5833	Focar C +3.5 close-up lens, 54mm	9.35	6.23	5.92
20.5834	Focar D +6.5 close-up lens, 54mm	9.35	6.23	5.92
20.5730	Lens hood for Septon and Skopagon lenses	4.00	2.67	2.54
23.7003	Case for filters and lens hood — 54mm	9.00	6.00	5.70
20.6604	54mm to 40.5mm reduction ring	3.00	2.00	1.90
23.7013	Case for 3 filters — 54mm	6.00	4.00	3.80
23.8033	Case, Ultramatic CS	18.95	12.63	12.00
23.8020	Case, Bessamatic M	16.50	11.00	10.45
23.8022	Case, Bessamatic, f/2, deluxe	16.50	11.00	10.45
PAGE H-4				
20.5031	Tripod Adapter	7.50	5.00	4.75
20.5001	Accessory Shoe	1.90	1.27	1.21
20.6621	Microscope adapter	7.50	5.00	4.75
20.6602	Micro connecting ring — 40.5mm	1.50	1.00	.95
20.6603	Micro connecting ring — 54mm	2.00	1.33	1.26
20.6622	Micro focusing attachment	50.00	33.33	31.66
20.6520	Right angle viewfinder	30.00	20.00	19.00
23.8028	Bessamatic camera sling	7.50	5.00	4.75
23.8038	Ultramatic camera sling	6.50	4.33	4.11
23.8027	Holster case	26.50	17.66	16.78
20.6522	Light Cap	.60	.40	.38
20.6521	Rubber Eye Cup	2.50	1.67	1.59

Item
Number

DESCRIPTION

PROFESSIONAL LENSES

Heliar f/4.5 Portrait Lenses

Designed to reproduce every detail, but with a certain effect of softness that yields live, delicate and flattering portraits, as well as fashion and advertising shots.

Heliar Lenses — In Normal Mount

12.0015	f/4.5 — 150mm	84.00
12.0035	f/4.5 — 180mm	114.00
12.0045	f/4.5 — 210mm	132.00
12.0055	f/4.5 — 240mm	189.00
12.0065	f/4.5 — 300mm	276.00

Heliar Lenses — In Shutter

12.0013	f/4.5 — 150mm in Synchro-Compur I Shutter	147.00
12.0033	f/4.5 — 180mm in X-Compur II Shutter	231.00
12.0043	f/4.5 — 210mm in X-Compound III Shutter	279.00
12.0044	f/4.5 — 210mm in Compur electronic 3 Shutter	348.00
12.0053	f/4.5 — 240mm in X-Compound IV Shutter	315.00
12.0054	f/4.5 — 240mm in Compur electronic 5 FS Shutter	468.00
12.0063	f/4.5 — 300mm in X-Compound V Shutter	396.00
12.0064	f/4.5 — 300mm in Compur electronic 5 FS Shutter	525.00

Universal Heliar f/4.5 Lenses

Well suited to portraiture with the same soft-sharp effect as the Heliar, but with the advantage of an adjustable central component that allows the photographer to obtain any desired degree of softness.

Universal Heliar Lenses — In Normal Mount

12.0067	f/4.5 — 300mm	315.00
12.0077	f/4.5 — 360mm	498.00
12.0087	f/4.5 — 420mm	636.00

Apo-Lanthar f/4.5 Lenses

Five element anastigmat lenses which are fully corrected for the three main color bands of the spectrum. They are designed for the particular requirements of the photographer who specializes in color work.

Apo-Lanthar Lenses — In Shutter

12.0103	f/4.5 — 105mm in Synchro-Compur O Shutter	138.00
12.0113	f/4.5 — 150mm in Synchro-Compur I Shutter	165.00
12.0143	f/4.5 — 210mm in X-Compound III Shutter	324.00
12.0144	f/4.5 — 210mm in Compur electronic 3 Shutter	390.00
12.0163	f/4.5 — 300mm in X-Compound IV Shutter	540.00
12.0164	f/4.5 — 300mm in Compur electronic 5 FS Shutter	666.00

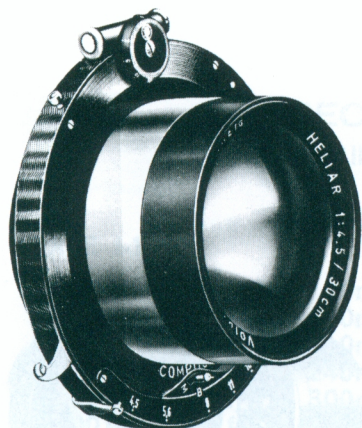

12.0063



12.0077

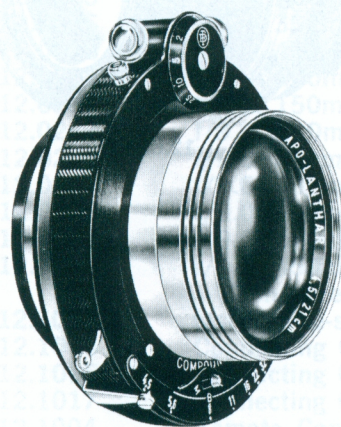

12.0143

PROFESSIONAL LENSES

ZEISS IKON
VOIGTLÄNDER

DESCRIPTION

Item
Number

Telomar f/5.5 Telephoto Lenses

Five element lenses of true telephoto construction with an optical design that results in extensive reduction of all aberrations and an increase in resolving power and detail contrast over the entire image area.

Telomar Lenses — In Shutter

f/5.5 — 180mm in Synchro-Compur 0 Shutter	180.00	12.0433
f/5.5 — 240mm in Synchro-Compur I Shutter	219.00	12.0453
f/5.5 — 360mm in X-Compound III Shutter	435.00	12.0473
f/5.5 — 360mm in Compur electronic 3 Shutter	498.00	12.0474

Apo-Skopar f/9 Process Lenses

Highly corrected apochromat lenses which give maximum sharpness at full aperture over the entire image area.

Apo-Skopar Lenses — In Normal Mount

f/8 — 75mm	111.00	12.0305
f/8 — 150mm	126.00	12.0315
f/9 — 210mm	135.00	12.0245
f/9 — 300mm	186.00	12.0265
f/9 — 450mm	276.00	12.0285
f/9 — 600mm	405.00	12.0295

Apo-Skopar Lenses — In Shutter

f/8 — 150mm in Synchro Compur 0 Shutter	165.00	12.0313
f/9 — 210mm in X-Compound III Shutter	246.00	12.0243
f/9 — 210mm in Compur electronic 3 Shutter	300.00	12.0244
f/9 — 300mm in X-Compound III Shutter	285.00	12.0263
f/9 — 300mm in Compur electronic 3 Shutter	339.00	12.0264
f/9 — 450mm in X-Compound IV Shutter	372.00	12.0283
f/9 — 450mm in Compur electronic 5 FS Shutter	525.00	12.0284

ACCESSORIES FOR COMPUR ELECTRONIC SHUTTERS

For Compur Electronic 3

f/stop Pre-selector	15.00	12.1033
Connecting Cord, 5 ft. long	15.00	12.1015
Connecting Cord, 13 ft. long	18.00	12.1016
Connecting Cord, 33 ft. long	27.00	12.1017

For Compur Electronic 5 FS

Remote Control Unit	249.00	12.1004
Extension Cord, 13 ft. long	9.00	12.1026
Extension Cord, 33 ft. long	12.00	12.1027

Voigtlander Reversing Mirrors

For use in process work to deflect the optical path 90° and procure correctly oriented images. The mirror, supported in a rigid cast housing, is absolutely flat and cannot produce any chromatic or astigmatic aberrations.

Reversion Mirror for Apo-Skopar Lenses

For Apo-Skopar 210mm, 300mm and 450mm lenses	480.00	12.0504
For Apo-Skopar 600mm lens	597.00	12.0509

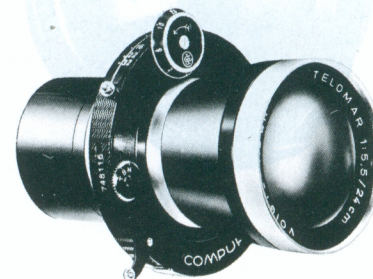

12.0453

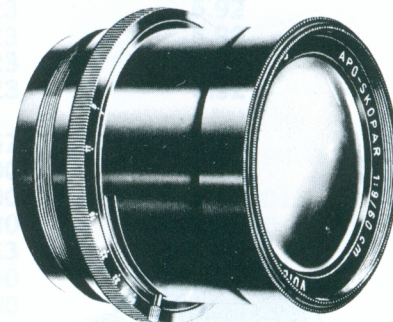

12.0295

CONFIDENTIAL DEALER PRICE SCHEDULE

EFFECTIVE MARCH 1, 1968

ZEISS IKON
VOIGTLÄNDER

SECTION I — PROFESSIONAL LENSES

All items are in Order of Appearance in Catalog Pages

PAGE I-1

		List		Net
12.0015	f/4.5, 150mm Heliar lens in barrel	84.00		56.00
12.0035	f/4.5, 180mm Heliar lens in barrel	114.00		76.00
12.0045	f/4.5, 210mm Heliar lens in barrel	132.00		88.00
12.0055	f/4.5, 240mm Heliar lens in barrel	189.00		126.00
12.0065	f/4.5, 300mm Heliar lens in barrel	276.00		184.00
12.0013	f/4.5, 150mm Heliar lens in shutter	147.00		98.00
12.0033	f/4.5, 180mm Heliar lens in shutter	231.00		154.00
12.0043	f/4.5, 210mm Heliar lens in shutter	279.00		186.00
12.0044	f/4.5, 210mm Heliar lens in Compur electronic 3 shutter	348.00		232.00
12.0053	f/4.5, 240mm Heliar lens in shutter	315.00		210.00
12.0054	f/4.5, 240mm Heliar lens in Compur electronic 5 FS shutter	468.00		312.00
12.0063	f/4.5, 300mm Heliar lens in shutter	396.00		264.00
12.0064	f/4.5, 300mm Heliar lens in Compur electronic 5 FS shutter	525.00		350.00
12.0067	f/4.5, 300mm Universal Heliar lens in barrel	315.00		210.00
12.0077	f/4.5, 360mm Universal Heliar lens in barrel	498.00		332.00
12.0087	f/4.5, 420mm Universal Heliar lens in barrel	636.00		424.00
12.0103	f/4.5, 105mm Apo-Lanthar lens in shutter	138.00		92.00
12.0113	f/4.5, 150mm Apo-Lanthar lens in shutter	165.00		110.00
12.0143	f/4.5, 210mm Apo-Lanthar lens in shutter	324.00		216.00
12.0144	f/4.5, 210mm Apo-Lanthar lens in Compur electronic 3 shutter	390.00		260.00
12.0163	f/4.5, 300mm Apo-Lanthar lens in shutter	540.00		360.00
12.0164	f/4.5, 300mm Apo-Lanthar lens in Compur electronic 5 FS shutter	666.00		444.00

PAGE I-2

12.0433	f/5.5, 180mm Telomar lens in shutter	180.00		120.00
12.0453	f/5.5, 240mm Telomar lens in shutter	219.00		146.00
12.0473	f/5.5, 360mm Telomar lens in shutter	435.00		290.00
12.0474	f/5.5, 360mm Telomar lens in Compur electronic 3 shutter	498.00		332.00
12.0305	f/8.0, 75mm Apo-Skopar lens in barrel	111.00		74.00
12.0315	f/8.0, 150mm Apo-Skopar lens in barrel	126.00		84.00
12.0245	f/9.0, 210mm Apo-Skopar lens in barrel	135.00		90.00
12.0265	f/9.0, 300mm Apo-Skopar lens in barrel	186.00		124.00
12.0285	f/9.0, 450mm Apo-Skopar lens in barrel	276.00		184.00
12.0295	f/9.0, 600mm Apo-Skopar lens in barrel	405.00		270.00
12.0313	f/8.0, 150mm Apo-Skopar lens in shutter	165.00		110.00
12.0243	f/9.0, 210mm Apo-Skopar lens in shutter	246.00		164.00
12.0244	f/9.0, 210mm Apo-Skopar lens in Compur electronic 3 shutter	300.00		200.00
12.0263	f/9.0, 300mm Apo-Skopar lens in shutter	285.00		190.00
12.0264	f/9.0, 300mm Apo-Skopar lens in Compur electronic 3 shutter	339.00		226.00
12.0283	f/9.0, 450mm Apo-Skopar lens in shutter	372.00		248.00
12.0284	f/9.0, 450mm Apo-Skopar lens in Compur electronic 5 FS shutter	525.00		350.00
12.1033	f/stop Pre-selector	15.00		10.00
12.1015	Connecting Cord, 5 ft. long	15.00		10.00
12.1016	Connecting Cord, 13 ft. long	18.00		12.00
12.1017	Connecting Cord, 33 ft. long	27.00		18.00
12.1004	Remote Control Unit	249.00		166.00
12.1026	Extension Cord, 13 ft. long	9.00		6.00
12.1027	Extension Cord, 33 ft. long	12.00		8.00
12.0504	Reversion Mirror for Apo-Skopar	480.00		320.00
12.0509	Reversion Mirror for Apo-Skopar	597.00		398.00

Item
Number

DESCRIPTION

ZEISS UMBRAL SUNGLASSES

ZEISS Umbral lenses offer superior and lasting protection for the eyes against glare and UV radiation, and they let you see your surroundings in their true, natural colors. Zeiss Umbral Sunglasses fitted in Metzler International frames are also most convenient to wear, extremely durable and very fashionable in appearance.

We supply all Zeiss Umbral Sunglasses with Plano-Lenses only.

LADIES' GLASSES

All ladies' glasses are supplied with 65% Umbral lenses ONLY.

Style No. 360

Alabaster — black

Cubana 12.95

Style No. 388

Havanna

Black — solid 14.95

Style No. 1000

Tortoise Shell

Black — solid 16.95

Style No. 383

Mango

Tortoise Shell 17.95

Style No. 1005

Tortoise Shell

Peat — black

Olive 21.95

Style No. 700

Gold Plated Metal Frame 23.95

"In Vogue" collection—three sophisticated styles in four exciting colors.

Style No. 1007

Golden Glow

Kelly Green

Deep Violet

Burnt Orange 18.95

Style No. 1008

Golden Glow

Kelly Green

Deep Violet

Burnt Orange 18.95

Style No. 1009

Golden Glow

Kelly Green

Deep Violet

Burnt Orange 18.95



360



388



1000



383



1005

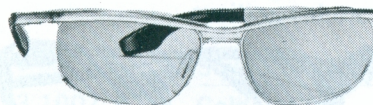

700



1007



1008



1009

73.0360
74.0360

73.0388
74.0388

73.1000
74.1000

73.0383
74.0383

73.1005
74.1005
75.1005

73.0700

73.1007
74.1007
75.1007
76.1007

73.1008
74.1008
75.1008
76.1008

73.1009
74.1009
75.1009
76.1009



DESCRIPTION

Item
Number

MEN'S GLASSES

All men's glasses are supplied with 85% Umbrales lenses ONLY.

Style No. 2000

Olive 16.95

Style No. 495

Brazil 18.95
Havanna

Style No. 2002

Havanna 19.95

Style No. 2003

Havanna 20.95
Black — solid

Style No. 2005

Havanna 22.95
Black — solid

Style No. 2006

Havanna 23.95
Olive

Style No. 750

Fleetmaster, gold-plated metal frame 25.95

Style No. 2602

Basalt 30.95

83.2000

83.0495
84.0495

83.2002

83.2003
84.2003

83.2005
84.2005

83.2006
84.2006

83.0750

83.2602



2000



495



2002



2003



2005



2006



750



2602



SECTION J — SUNGLASSES

All items are in Order of Appearance in Catalog Pages

LADIES' GLASSES

All ladies' glasses are supplied with 65% Umbral lenses ONLY.

Cat. No.	Style and Color	1 pc. net	12 pc. net	24 pc. net	List
<u>Style No. 360</u>					
73.0360	Alabaster — black				
74.0360	Cubana	7.77	7.12	6.48	12.95
<u>Style No. 388</u>					
73.0388	Havana				
74.0388	Black — solid	8.97	8.22	7.48	14.95
<u>Style No. 1000</u>					
73.1000	Tortoise shell				
74.1000	Black — solid	10.17	9.32	8.48	16.95
<u>Style No. 383</u>					
73.0383	Mango				
74.0383	Tortoise Shell	10.77	9.87	8.98	17.95
<u>Style No. 1005</u>					
73.1005	Tortoise Shell				
74.1005	Peat — black				
75.1005	Olive	13.17	12.07	10.98	21.95
<u>Style No. 700</u>					
73.0700	Gold Plated Metal Frame	14.37	13.17	11.98	23.95
"In Vogue" collection		1 pc.	9 pc.	18 pc.	
exciting colors.		net	net	net	List
<u>Style No. 1007</u>					
73.1007	Golden Glow				
74.1007	Kelly Green				
75.1007	Deep Violet				
76.1007	Burnt Orange	11.37	10.42	9.48	18.95
<u>Style No. 1008</u>					
73.1008	Golden Glow				
74.1008	Kelly Green				
75.1008	Deep Violet				
76.1008	Burnt Orange	11.37	10.42	9.48	18.95
<u>Style No. 1009</u>					
73.1009	Golden Glow				
74.1009	Kelly Green				
75.1009	Deep Violet				
76.1009	Burnt Orange	11.37	10.42	9.48	18.95

CONFIDENTIAL DEALER PRICE SCHEDULE

EFFECTIVE MARCH 1, 1968



SECTION J — SUNGLASSES

All items are in Order of Appearance in Catalog Pages

MEN'S GLASSES

All men's glasses are supplied with 85% Umbral lenses ONLY.

Cat. No.	Style and Color	1 pc. net	12 pc. net	24 pc. net	List
	<u>Style No. 2000</u>				
83.2000	Olive	10.17	9.32	8.48	16.95
	<u>Style No. 495</u>				
83.0495	Brazil				
84.0495	Havanna	11.37	10.42	9.48	18.95
	<u>Style No. 2002</u>				
83.2002	Havanna	11.97	10.97	9.98	19.95
	<u>Style No. 2003</u>				
83.2003	Havanna				
84.2003	Black — solid	12.57	11.52	10.48	20.95
	<u>Style No. 2005</u>				
83.2005	Havanna				
84.2005	Black — solid	13.77	12.62	11.48	22.95
	<u>Style No. 2006</u>				
83.2006	Havanna				
84.2006	Olive	14.37	13.17	11.98	23.95
	<u>Style No. 750</u>				
83.0750	Fleetmaster, gold-plated metal frame	15.57	14.27	12.98	25.95
	<u>Style No. 2602</u>				
83.2602	Basalt	18.57	17.02	15.48	30.95



Item
Number

DESCRIPTION

Three outstanding features of the new CARL ZEISS binoculars:

- Increased marginal sharpness . . . through the use of 6-lens oculars.
- Reduced overall dimensions . . . with tele-objectives, Zeiss binoculars are smaller, lighterweight than other binoculars of like capacity.
- Optical design . . . for use with or without eyeglasses, there are the special "B" models: 7x50B, 8x30B, 8x50B.



52.0430



52.0434



52.0450

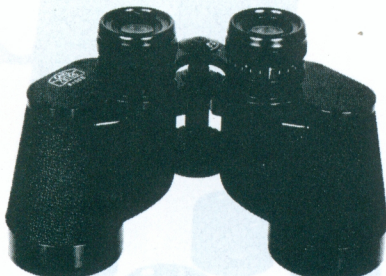

52.0452

ZEISS PRISM BINOCULARS

(Complete with neck strap and leather case)

52.0430	NEW 8x30B DIALYT for use with or without eyeglasses, central focusing, for traveling, sports and bird watching (1)82106-00/(3)36100-70	159.00*
52.0432	8x30 central focusing, for hunting, stalking, as well as traveling, sports, bird watching (1)44129-33/(3)51122-86	194.00*
52.0434	8x30B central focusing, with reversible soft-rubber eyecups for use with or without eyeglasses and sunglasses (1)55132-67/(3)73126-04	199.00*
52.0450	7x50B individual focusing, a night glass, for use with or without eyeglasses, particularly valuable as a marine binocular (1)83158-67/(3)21150-74	238.00*
52.0452	8x50B central focusing, for use with or without eyeglasses, night glass, large viewing field for hunters and woodsmen (1)99192-67/(3)88183-04	289.00*
52.0454	10x50 central focusing, a day or dusk and dawn glass for hunting, ornithology, aviation, safety services, engineering (1)55215-33/(3)62204-56	323.00*
52.0464	15x60 central focusing, high twilight performance, for hunting, ornithology, aviation, engineering, and amateur astronomy, as well as exploring (1)87252-00/(3)77239-40	378.00*
52.5500	7x50B/GA seawater resistant with rubber protection, individual eye-piece focusing (no case required) (1)67152-67/(3)21145-04	229.00*

MONOCULARS

(Without Neck Cord or Case)

20.1629	MONOCULAR 8x30B, 8x magnification, light-weight and compact, used for observation, reading, spotting scope, with or without eyeglasses; can also be used as tele-attachment for Contaflex camera; extends focal length of standard lens from 50mm to 400mm. (1)6472-00/(3)3868-40	108.00
—	MONOCULAR 15x60 15x magnification, light-weight glass with tripod socket; can be mounted directly on camera tripod (1)27112-67/(3)49107-04	169.00

CARRYING CASES

52.9050	LUXURY CARRYING CASE (Type D) for Dialyt 8x30B (1)888-00/(3)547-60	12.00
52.0328	LUXURY CARRYING CASES (Type N) for 8x30, and 8x30B (1)8710-00/(3)149-50	15.00
52.0533	for 7x50B and 8x50B (1)9914-00/(3)2213-30	21.00
52.0537	for 10x50 (1)2614-00/(3)3113-30	21.00
52.0651	for 15x60 (1)4720-00/(3)5219-00	30.00
23.1203	CASE, leather for Monocular 8x30B (1)777-00/(3)296-65	10.50

BINOCULARS



DESCRIPTION

Item Number

BINOCULAR ACCESSORIES

NECK STRAP for binoculars(1)851-00	each	1.50	52.9130
For DIALYT 8x30B			52.9100
for 8x30, 8x30B			52.9101
for 7x50B, 8x50B, 10x50, and 15x60			
SHOULDER STRAP for standard case "N"(1)191-60		2.40	52.9110
SHOULDER STRAP for standard case (Type D)(1)691-60		2.40	52.9111
SHOULDER PAD (fits all straps for leather cases)(1)730-60		.90	52.9160
RAIN GUARD (fits all Zeiss binoculars)(1)111-60		2.40	52.0345 (9901)
BUTTON ANCHOR STRAP(1)190-60		.90	52.0335
REPLACEMENT EYE-CUPS (except for 8x30B, 7x50B and 8x50B), (Specify inner diameter of eyecup threads) each eyecup			
(1)490-80	each	1.20	—
FLAT RUBBER EYECUPS for eyeglass wearers, all models (specify inner diameter of eyecup threads) . . .(1)332-80	pair	4.20	—
CONVERTIBLE SOFT RUBBER EYECUPS for 8x30B, 7x50B and 8x50B(1)932-80	pair	4.20	—
UMBRAL LENSES (slip-on mounts)(1)656-00	pair	9.00	52.0102
SOLAR OBSERVATION GLASSES (slip-on mounts)			
(1)276-00	pair	9.00	52.0103
POLARIZING FILTERS (slip-on mounts)(1)4712-00	pair	18.00	52.0104
UMBRAL LENSES for B-models(1)496-00	pair	9.00	52.0112
SOLAR OBSERVATION GLASSES for B-models . . .(1)596-00	pair	9.00	52.0113
POLARIZING FILTER for B-models(1)5712-00	pair	18.00	52.0114
PUNKAL EYE CORRECTION LENSES (slip-on mounts, made to prescription),(1)334-60	from each	6.90 up	—
RUBBER GUARDS for 7x50B binoculars only . . .(1)516-00	set	9.00	52.0584
TRIPOD ADAPTER for binoculars(1)376-00		9.00	52.0361
GRATICULE F-1 or F-2 (installed on special order) . .(1)6912-00		18.00	—



52.0454

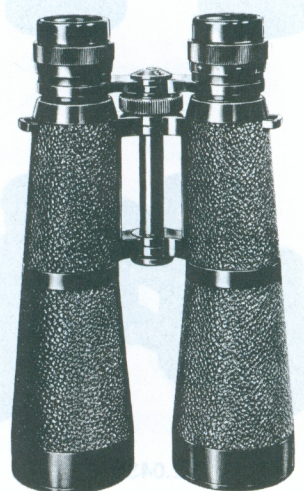

52.0456

CLOSE-UP LENSES

(For 8x30 and 8x30B monocular or binoculars—usable only in front of one binocular lens)

1 DIOPTER , for observation at approximately 40 inches (1)556-67	each	10.00	52.0371
2 DIOPTERS , for observation at approximately 20 inches (1)8110-00	each	15.00	52.0372
3 DIOPTERS , for observation at approximately 13 inches (1)8913-33	each	20.00	52.0373
5 DIOPTERS , for observation at approximately 8 inches (1)7216-67	each	25.00	52.0375
8 DIOPTERS , for observation at approximately 5 inches (1)2220-00	each	30.00	52.0378

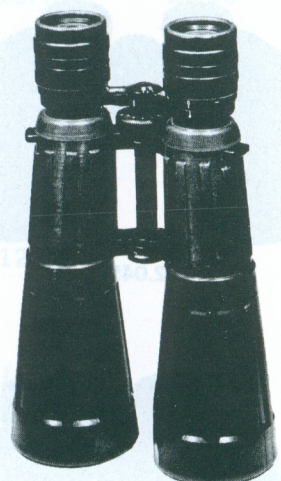

52.0457

HENSOLDT PRISM BINOCULARS

(Complete with Neck Strap and Leather Case)

8x56 DIALYT central focusing special night glass, extremely high twilight performance(1)57150-67/(3)81143-14	226.00*	52.0456
NIGHT-DIALYT 8x56 B/GA for use with or without eyeglasses, sealed in rubber armor, excellent for hunting and outdoor uses (1)86188-67/(3)32179-24	283.00*	52.0457



52.0371-78



Item
Number

DESCRIPTION

HENSOLDT PRISM BINOCULARS (Cont'd)



52.0981

52.0981 DIASPORT 8x20 central focusing, pocket size prism glass, with soft leather pouch "T"(1)1475-33/(3)4871-56 113.00*

52.0980 DIASPORT 8x20, same as above with rigid leather case "U"(1)1876-67/(3)2472-84 115.00*

HENSOLDT THEATRE GLASSES

(Complete with Luxury Leather Case in matching colors)

DIADEM 2 1/2x30 central focusing, clear view for the theatre lover. A beautiful glass in a wide range of colors:

14.4100 Luxury model with coated optics, gold with black(1)5436-00/(3)3734-20 54.00*

14.8100 Luxury model—mother-of-pearl and gold with coated optics, with black, maroon, or mauve(1)9746-00/(3)8643-70 69.00*

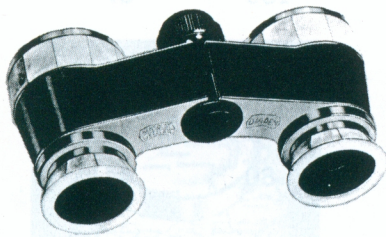

14.8100

CARRYING CASES

DIALYT

52.9096 8x56, case "N"(1)3510-00/(3)139-50 15.00

52.9095 8x56 B/GA (Night)(1)7910-00/(3)769-50 15.00

DIASPORT

52.9088 Soft pouch "T"(1)942-67/(3)512-54 4.00

52.9089 Rigid case "U"(1)794-00/(3)623-80 6.00

DIADEM

52.7900 Luxury case in matching colors(1)523-33/(3)193-16 5.00

TELESCOPES

MONO DIALYT
(With Forked Holder)

52.6800 40x60(1)55119-34/(3)54113-37 179.00

52.9086 Case(1)3310-00/(3)229-50 15.00



52.0328

BINOCULARS



CARL ZEISS BINOCULARS — TECHNICAL DATA

MODEL	Magnification M	x	Clear objective diameter D (mm)	Exit pupil (mm)	Twilight Performance √ MxD	FIELD OF VIEW		Weight approx. ozs.
						Angular measure (degrees)	Yards at 1,000 yards	
DIALYT	8	x	30B	3.75	15.5	7°24'	130	23
CZ	8	x	30	3.75	15.5	8°30'	150	17½
CZ	8	x	30B	3.75	15.5	6°18'	110	17
CZ	7	x	50B	7.1	18.7	7°24'	130	34
CZ	8	x	50B	6.25	20.0	7°24'	130	37
CZ	10	x	50	5.0	22.4	7°24'	130	35
CZ	15	x	60	4.0	30.0	4°30'	80	44½
MONOCULAR	8	x	30B	3.75	15.5	6°18'	110	9
MONOCULAR	15	x	60	4.0	30.0	4°30'	80	21
DIALYT	8	x	56	7.0	21.2	6°15'	110	25
DIALYT	8	x	56B/GA	7.0	21.2	6°15'	110	35
DIASPORT	8	x	20	2.5	...	6°54'	120	8¾



Item
Number

DESCRIPTION

CARL ZEISS MAGNIFIERS



52.8040

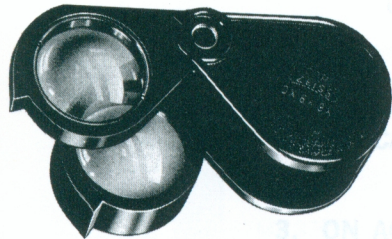

52.8009



52.8220

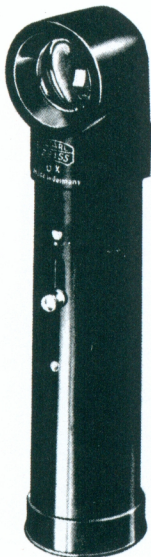

52.8200-06

Item Number	DESCRIPTION	
52.8040	BINOCULAR HEAD BAND MAGNIFIER . . . (1)3810-00/(3)499-50	15.00
52.8006	FOLDING MAGNIFIER 6x (1)447-33/(3)816-96	11.00
52.8010	FOLDING MAGNIFIER 10x (1)447-33/(3)796-96	11.00
52.8009	DOUBLE FOLDING MAGNIFIER 3x, 6x, 9x (1)5310-67/(3)7810-14	16.00
52.8205	TELUPAN, in case (1)4810-00/(3)409-50	15.00
52.8220	MAP READING MAGNIFIER with handle, magnif. head 1.7x and bulb, w/o batteries (two C-size batteries, 1.5 volts required) (1)3910-00/(3)379-50	15.00
52.8222	CASE for Map Reading Magnifier (1)391-67/(3)971-59	2.50
38.0115	BULB 2.5 V./0.2A for Map Reading Magnifier (1)320-33/(3)490-31	.50
52.8200	ILLUMINATING POCKET MAGNIFIER with handle, without bulb and battery (1)176-33/(3)446-01	9.50
52.8203	MAGNIFIER HEAD 3x (1)447-33/(3)796-96	11.00
52.8206	MAGNIFIER HEAD 6x (1)517-33/(3)646-96	11.00
52.8208	MAGNIFIER HEAD 8x (1)227-33/(3)216-96	11.00
52.8210	MAGNIFIER HEAD 10x (1)577-33/(3)396-96	11.00
	BULB 3V. 0.45W. with hood (1)810-67/(3)370-63	1.00
52.8230	ILLUMINATING MAGNIFIER with focusing mount, base plate, lamp housing, without bulb (1)3418-00/(3)5216-20	27.00
52.8233	FROSTED SCREEN (1)930-67/(3)350-60	1.00
52.8232	DAYLIGHT FILTER (1)770-67/(3)820-60	1.00
52.8236	APLANATIC MAGNIFIER 6x (1)667-33/(3)446-60	11.00
52.8238	APLANATIC MAGNIFIER 8x (1)397-33/(3)286-60	11.00
52.8234	MICROSCOPE TUBE with objective T 5.4x (1)8312-67/(3)4911-40	19.00
46.3710	EYEPIECE C 5x (1)3811-25	15.00
52.8212	COUNTING RETICULE div. 1/4", 1/2", 1" . . (1)443-00/(3)742-70	4.50
52.8214	NET MICROMETER 30mm (1)768-67/(3)497-80	13.00
52.8215	CIRCLE MICROMETER 30mm (1)746-99/(3)815-40	9.00
38.0116	BULB 110 V. 15 W. (1)790-33/(3)490-30	.50



CARL ZEISS BINOCULARS

CARL ZEISS MAGNIFIERS

1. ON BINOCULARS, THEATRE GLASSES, MONOCULARS, TELESCOPES AND MAGNIFIERS

- On one and two pieces **33¹/₃%**
- On three and more pieces, if ordered at one time **33¹/₃%**

Plus 5% on Net

2. ON CASES . . . Same discounts as for Binoculars

3. ON ACCESSORIES, Any quantity 33¹/₃%

We have coded the dealer net price with the following widely used coding system: the numbers in parenthesis indicate quantity net prices; (1) for one or two pieces; (3) for three or more pieces. The first two digits following the parenthesis are dummies which should be ignored. The remaining number gives the dealer net price in dollars and cents. To avoid error, there is always a hyphen between the dollars and cents.

FEDERAL EXCISE TAX OF 10% must be added to your selling price of binoculars only. When binocular and case are invoiced together, excise tax is due only on binocular.



MECABLITZ ELECTRONIC FLASHGUNS

MECABLITZ 116 with AC cord and PC cord, without type C batteries, without camera bracket . . . (1)7826-63/(3)9425-30	39.95
AC CORD only for MB 116 (1)223-33/(3)943-16	5.00
CASE , leather for MB 116 (1)773-83/(3)513-64	5.75
MECABLITZ 117 with AC charger and PC cord, without camera bracket (1)4339-97/(3)9637-97	59.95
CASE , leather for MB 117 (1)483-83/(3)343-64	5.75
MECABLITZ 118 with AC charger and PC cord, without camera bracket (1)7249-97/(3)1147-47	74.95
CASE , leather for MB 118 (1)483-83/(3)423-64	5.75
CAMERA BRACKET for MB 111, 115, 116, 117 or 118 (1)992-00/(3)461-90	3.00
MECABLITZ 502 with NC battery (1)25113-00/(3)33107-36	169.50
MECATWIN 502 EXTENSION UNIT (1)9933-30/(3)2831-64	49.95
AC UNIT for Mecablitz 502 (1)3439-97/(3)1837-97	59.95
BRACKET for modeling light (without bulb) (1)273-00/(3)422-85	4.50
CLAMP for above bracket (1)441-00/(3)140-95	1.50

MB-116

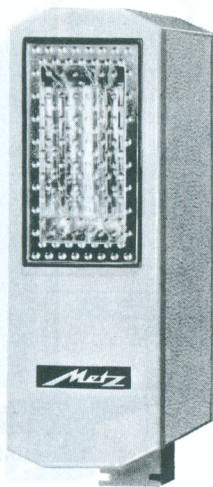

MB-117

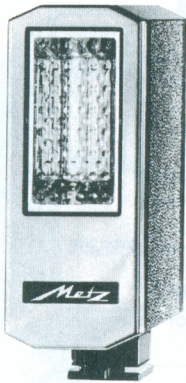

MB-118

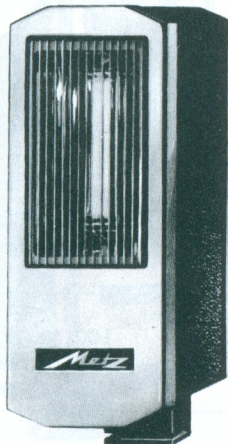

MB-502

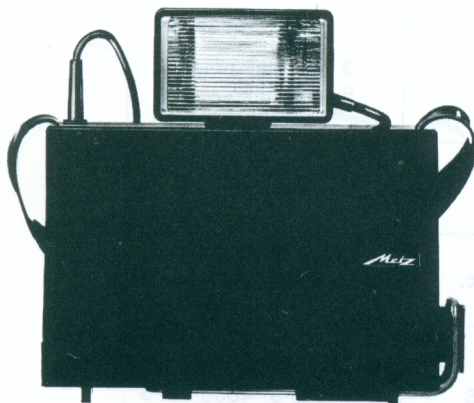



Specifications

		MB 116	MB 117	MB 118	MB 502
Approx. Case Dimensions		5 x 1 $\frac{1}{16}$ x 3 $\frac{3}{8}$ "	4 x 1 $\frac{1}{16}$ x 2 $\frac{5}{8}$ "	4 $\frac{5}{8}$ x 1 $\frac{1}{16}$ x 3 $\frac{1}{8}$ "	7 $\frac{3}{4}$ x 5 x 2 $\frac{1}{4}$ " Reflector: 3 $\frac{1}{2}$ x 7 x 3"
Approx. Weight		16 ozs. with batteries	10 ozs.	14 ozs.	5 $\frac{1}{2}$ lbs.
Guide No.	Kodachrome II	34 - 30	34 - 30	40 - 36	56 half power 80 full power
	Kodachrome X	54 - 48	54 - 48	65 - 57	82 half power 118 full power
Color Temperature Matches		5500°K Daylight Color Film	5500°K Daylight Color Film	5500°K Daylight Color Film	5500°K Daylight Color Film
Reflector Coverage		65° (wide angle)	65° (wide angle)	65° (wide angle)	65° (wide angle)
Approx. No. of Flashes per Charge	AC	unlimited	unlimited	unlimited	unlimited
	Replaceable Battery	50 - 170	N.A.	N.A.	200 full power WET 400 half power CELL
	NC Battery	N.A.	45	45	100 full power 200 half power
Approx. Recycling Time	AC	9 sec. 110 Volt AC	9 sec. 110/220 Volt AC	9 sec. 110/220 Volt AC	3 sec. half power 5 sec. full power
	Battery (Dry Cell)	9 - 15 sec.	9 sec.	9 sec.	3 sec. half power 5 sec. full power
Battery Charger		N.A.	separate	separate	separate
Flash Duration		1/1000 sec.	1/1000 sec.	1/1000 sec.	1/1000 sec.
Power Rating		25 Ws 700 ECPS	25 Ws 700 ECPS	40 Ws 1200 ECPS	60 Ws half 120 Ws full 2000 ECPS 4000 ECPS



MECABLITZ® ELECTRONIC FLASHGUNS

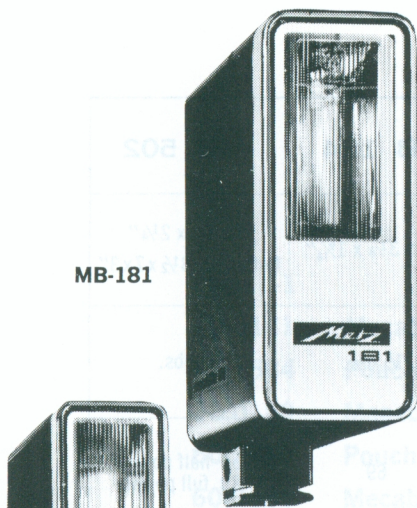

MB-181



MB-180

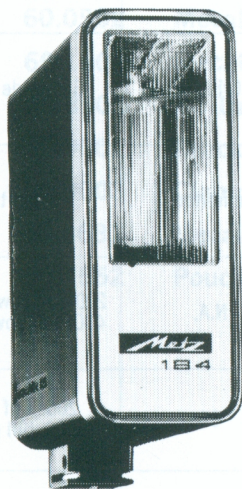

MB-184

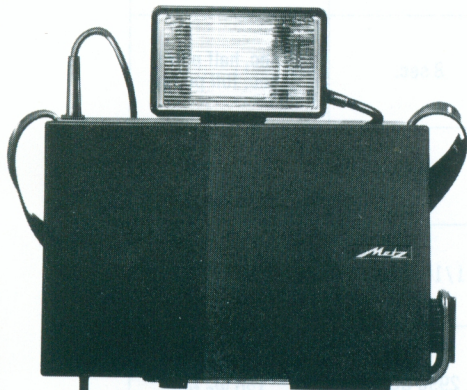

MB-502

60.0181	MECABLITZ® 181 with AC cord and PC cord, without batteries, without camera bracket (4 type AA batteries required)	39.95
60.7584	POUCH, zipper for MB 181, 184, 163, 171	5.75
60.0180	MECABLITZ® 180 with AC charger and PC cord, without camera bracket	49.95
60.7580	POUCH, zipper for MB 180	5.75
60.0182	MECABLITZ® 182 with AC charger and PC cord, without camera bracket	59.95
60.7582	POUCH, zipper for MB 182, 160	5.75
60.0184	MECABLITZ® 184 with AC charger and PC cord, without camera bracket	74.95
60.7584	POUCH, zipper for MB 184, 181, 163, 171	5.75
60.9000	CAMERA BRACKET for MB 181, 180, 182 and 184	3.00
60.0502	MECABLITZ® 502 with NC battery	169.50
60.1502	MECATWIN® 502 EXTENSION UNIT	49.95
60.8502	AC UNIT for Mecablitz 502	59.95
60.9002	BRACKET for modeling light (without bulb)	7.50
60.9003	CLAMP for above bracket	3.00
60.0681	MECALUX, slave unit, without battery (one 15 V. battery required)	34.95
60.7562	POUCH, zipper, for MB 162, 117, 182	5.75



		MB 181	MB 180	MB 182	MB 184	MB 502
Approx. Case Dimensions		4½ x 3 x 1½"	3¾ x 2¼ x 1½"	3¾ x 2¾ x 1½"	4½ x 3½ x 1½"	7¾ x 5 x 2¼" Reflector: 3½ x 7 x 3"
Approx. Weight		8 ozs. w/o batteries	5¼ozs.	7 ozs.	13½ ozs.	5½ lbs.
Guide No.	Kodachrome II	44	35	44	69	56 half power 80 full power
	Kodachrome X	70	56	70	110	82 half power 118 full power
Color Temperature Matches		5500°K Daylight Color Film	5500°K Daylight Color Film	5500°K Daylight Color Film	5500°K Daylight Color Film	5500°K Daylight Color Film
Reflector Coverage		65° (wide angle)	65° (wide angle)	65° (wide angle)	65° (wide angle)	65° (wide angle)
Approx. No. of Flashes per Charge	AC	unlimited	unlimited	unlimited	unlimited	unlimited
	Replaceable Battery	50 - 180 Four size AA batteries	N.A.	N.A.	N.A.	200 full power WET 400 half power CELL
	Built-in NC Battery	N.A.	40	50	65	200 half power 100 full power
Min. Recycling Time	AC	9 sec. 115 Volt AC	10 sec. 115/220 Volt AC	9 sec. 115/220 Volt AC	8 sec. 115/220 Volt AC	3 sec. half power 5 sec. full power
	Battery (Dry Cell)	9 - 15 sec.	10 sec.	9 sec.	8 sec.	3 sec. half power 5 sec. full power
Battery Charger		N.A.	separate	separate	separate	separate
Flash Duration		1/1000 sec.	1/1000 sec.	1/1000 sec.	1/1000 sec.	1/1000 sec.
Power Rating		1200 BCPS	770 BCPS	1200 BCPS	2990 BCPS	60 Ws half 2000 ECPS 120 Ws full 4000 ECPS

— Use on AC current only —

CONFIDENTIAL DEALER PRICE SCHEDULE

EFFECTIVE OCTOBER 1, 1968



SECTION L — MECABLITZ

All Items are in Order of Appearance in Catalog Pages

Page L-1		List	1-2 pc. net	3 and more pc. net
60.0181	Mecablitz 181	39.95	26.63	23.97
60.7584	Pouch f. MB 181	5.75	3.83	3.64
60.0180	Mecablitz 180	49.95	33.30	29.97
60.7580	Pouch f. MB 180	5.75	3.83	3.64
60.0182	Mecablitz 182	59.95	39.97	35.97
60.7582	Pouch f. MB 182	5.75	3.83	3.64
60.0184	Mecablitz 184	74.95	49.97	44.97
60.7584	Pouch f. MB 184	5.75	3.83	3.64
60.9000	Camera Bracket f. MB 180, 181, 182, 184	3.00	2.00	1.90
60.0502	Mecablitz 502 W/N/C Battery	169.50	113.00	107.36
60.1502	Mecatwin® 502 Extension Unit	49.95	33.30	31.64
60.8502	AC Unit f. MB 502	59.95	39.97	37.97
60.9002	Bracket, modeling light	7.50	5.00	4.75
60.9003	Clamp f. Bracket	3.00	2.00	1.90
60.0681	Mecalux	34.95	23.30	22.14
60.7562	Pouch f. MB 162	5.75	3.83	3.64

№ 539

This reprint of the **Zeiss Ikon-Voigtländer 1965/1968 Dealer Price Schedules** is presented by The Zeiss Historica Society of America in conjunction with our stated objective to study and exchange information on the significant products and innovations of that firm.

Address inquiries to: **The Zeiss Historica Society**, 300 Waxwing Drive, Cranbury, NJ 08512, U.S.A.

© Zeiss Historica Society 1990. All rights reserved under Pan American and Universal Copyright Conventions by Zeiss Historica Society. Reproduction without permission is prohibited.